

# VINTAGE KEYS

CLASSIC ANALOG KEYBOARDS



## OPERATION MANUAL



E-mu Systems, Inc.

# VINTAGE KEYS

CLASSIC ANALOG KEYBOARDS

## Operation Manual

© 1992 E-mu Systems, Inc.  
All Rights Reserved

### • FI407 Rev. C

Manual - Riley Smith  
Design & Cover - Nancy Enge

#### E-mu World Headquarters

E-mu Systems, Inc. U.S.A.  
P.O. Box 660015  
Scotts Valley, CA USA  
95067-0015  
Telephone: 408-438-1921  
Fax: 408-438-8612

#### Europe, Africa, Middle East

E-mu Systems, Ltd.  
Suite 6, Adam Ferguson  
House  
Eskmills Industrial Park  
Musselburgh, East Lothian  
Scotland, EH21 7PQ  
Telephone: 44-31-653-6556  
Fax: 44-31-665-0473

#### *Important Notice:*

In order to obtain warranty service on your Vintage Keys unit, the serial number sticker must be intact and you must have a sales receipt or other proof of purchase. If there is no serial number sticker on Vintage Keys, please contact E-mu Systems at once.

*This product is covered under one or more of the following U. S. patents: 3,969,682; 3,986,423; 4,404,529; 4,506,579; 4,699,038; 4,987,600; 5,013,105; 5,072,645; 5,111,727 and foreign patents and/or pending patents. Vintage keys is a registered trademark of E-mu Systems, Inc.*

## **IMPORTANT SAFETY INSTRUCTIONS**

Use in countries other than the U.S.A. may require the use of a different line cord or attachment plug, or both. To reduce the risk of fire or electric shock, refer servicing to qualified service personnel. To reduce risk of fire or electric shock do not expose this product to rain or moisture.

## **GROUNDING INSTRUCTIONS**

This product must be grounded. If it should malfunction or break down, grounding provides a path of least resistance for electric current, reducing the risk of electric shock. This product is equipped with a cord having an equipment-grounding conductor and a grounding plug. The plug must be plugged into an appropriate outlet properly installed and grounded in accordance with all local codes and ordinances.

## **DANGER**

Improper connection of equipment grounding conductor can result in the risk of electric shock. Check with a qualified electrician or service personnel if you are in doubt as to whether the product is properly grounded. Do not modify the plug provided with this product — if it will not fit the outlet, have a proper outlet installed by a qualified technician.

## **CAUTION**

If the 9045, Vintage Keys is rack mounted, a standard 19-inch open frame rack must be used.

## **USER-MAINTENANCE INSTRUCTIONS**

1. Vintage Keys should be kept clean and dust free. Periodically wipe the unit with a clean, lint free cloth. Do not use solvents or cleaners.
2. There are no user lubrication or adjustment requirements.
3. Refer all other servicing to qualified service personnel.

## **INSTRUCTIONS PERTAINING TO A RISK OF FIRE, ELECTRIC SHOCK, OR INJURY TO PERSONS**

***WARNING; When using electric products, basic precautions should always be followed, including the following:***

1. Read all instructions before using Vintage Keys.
2. To reduce the risk of injury, close supervision is necessary when Vintage Keys is used near children.
3. Do not use Vintage Keys near water — for example near a bathtub, wash-bowl, kitchen sink, in a wet basement, on a wet bar, or near or in a swimming pool.



*This symbol is intended to alert the user to the presence of important operating and maintenance (servicing) instructions in the literature accompanying the appliance.*

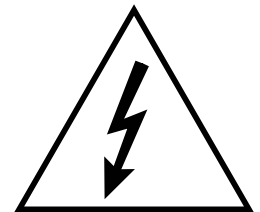

*This symbol is intended to alert the user to the presence of uninsulated dangerous voltage within the product's enclosure that may be of sufficient magnitude to constitute a risk of electric shock to persons.*

## SAVE THESE INSTRUCTIONS

---

4. Vintage Keys should be situated so that its location or position does not interfere with its proper ventilation.
5. Vintage Keys should be located away from heat sources such as radiators, heat registers, fireplaces, stoves, or ovens.
6. Vintage Keys should only be connected to a power supply of the type described in the operating instructions and as marked on the product.
7. This product, in combination with an amplifier and headphones and speakers, may be capable of producing sound levels that could cause permanent hearing loss. Do not operate for a long period of time at a high volume level or at a level that is uncomfortable. If you experience any hearing loss or ringing in the ears, consult an audiologist.
8. Vintage Keys may be equipped with a polarized line plug (one blade wider than the other). This is a safety feature. If you are unable to insert this plug into the outlet, do not defeat the safety purpose of the plug. Contact an electrician to replace your obsolete outlet.
9. The power supply cord of Vintage Keys should be unplugged from the outlet when left unused for a long period of time.
10. Care should be taken so that objects do not fall and liquids are not spilled into the enclosure of Vintage Keys through openings.
11. The product should be serviced by qualified service personnel when:
  - A. The power supply cord has been damaged; or
  - B. Objects have fallen, or liquid has been spilled into the product; or
  - C. The product has been exposed to rain; or
  - D. The product does not appear to operate normally or exhibits a marked change in performance; or
  - E. The product has been dropped or the enclosure damaged.
12. All servicing should be referred to qualified service personnel.

## SAVE THESE INSTRUCTIONS

<b>INTRODUCTION &amp; BASIC SETUP</b>	<b>1</b>
<i>Introduction</i> .....	3
<i>Vintage Keys Organization</i> .....	4
<i>Connection Instructions</i> .....	5
<b>BASIC OPERATION</b>	<b>9</b>
<i>Main Controls</i> .....	11
<i>Selecting MIDI Channels</i> .....	12
<i>Selecting Presets</i> .....	12
<i>Adjusting Volume &amp; Pan Position</i> .....	12
<i>Playing the Demo Sequences</i> .....	13
<i>Multi-Timbral Operation</i> .....	13
<i>About Vintage Keys</i> .....	14
<b>MASTER MENU</b>	<b>15</b>
<i>Enabling the Master Menu</i> .....	17
<i>Master Tune</i> .....	17
<i>Transpose</i> .....	18
<i>Global Bend</i> .....	18
<i>Global Velocity Curve</i> .....	18
<i>Mix Output</i> .....	20
<i>MIDI Mode</i> .....	20
<i>MIDI Mode Change</i> .....	21
<i>MIDI Overflow</i> .....	21
<i>MIDI Enable</i> .....	21
<i>Preset Change</i> .....	21
<i>MIDI Controller Assign</i> .....	22
<i>MIDI Footswitch Assign</i> .....	22
<i>MIDI Program → Preset</i> .....	22
<i>Send MIDI Data</i> .....	23
<i>User Key Tuning</i> .....	24
<i>Viewing Angle</i> .....	24
<b>PROGRAMMING BASICS</b>	<b>25</b>
<i>Modulation</i> .....	28
<i>Modulation Sources</i> .....	29
<i>Envelope Generators</i> .....	30
<i>Low Frequency Oscillators</i> .....	31
<i>MIDI Patch</i> .....	32

## PROGRAMMING BASICS (continued)

<i>Filter Modulation</i> .....	33
<i>Vintage Keys Signal Flow</i> .....	36
<i>Keyboard &amp; Velocity Modulation</i> .....	37
<i>Key Number</i> .....	38
<i>Velocity Curves</i> .....	38
<i>Realtime Modulation</i> .....	39
<i>MIDI Realtime Controls</i> .....	40
<i>Stereo Mix Outputs</i> .....	42

## EDIT MENU 43

<i>Enabling the Edit Menu</i> .....	45
<i>Preset Name</i> .....	46
<i>Primary Instrument</i> .....	47
<i>Secondary Instrument</i> .....	47
<i>Key Range</i> .....	47
<i>Primary Key Range</i> .....	48
<i>Secondary Key Range</i> .....	48
<i>Coarse Tuning</i> .....	49
<i>Fine Tuning</i> .....	49
<i>Volume</i> .....	49
<i>Pan</i> .....	49
<i>Alternate Envelope On/Off</i> .....	50
<i>Primary Alternate Envelope Parameters</i> .....	50
<i>Secondary Alternate Envelope Parameters</i> .....	50
<i>Delay</i> .....	51
<i>Sound Start</i> .....	51
<i>Reverse Sound</i> .....	51
<i>Solo Mode</i> .....	52
<i>Portamento Rate</i> .....	52
<i>Chorus</i> .....	52
<i>Crossfade Mode</i> .....	53
<i>Crossfade Direction</i> .....	54
<i>Crossfade Amount</i> .....	55
<i>Cross-switch Point</i> .....	55
<i>Primary Filter Type</i> .....	55
<i>Primary Filter Cutoff &amp; Q</i> .....	56
<i>Secondary Filter Type</i> .....	56
<i>Secondary Filter Cutoff &amp; Q</i> .....	56
<i>Auxiliary Envelope</i> .....	57
<i>LFO 1 - Shape &amp; Amount</i> .....	58

**EDIT MENU (continued)**

<i>LFO 1 - Rate, Delay &amp; Variation</i> .....	58
<i>LFO 2 - Shape &amp; Amount</i> .....	59
<i>LFO 2 - Rate, Delay &amp; Variation</i> .....	59
<i>Keyboard &amp; Velocity Modulation Control</i> .....	60
<i>Realtime Modulation Control</i> .....	61
<i>Footswitch Control</i> .....	62
<i>Pitch Bend Range</i> .....	62
<i>Pressure Amount</i> .....	62
<i>MIDI Controller Amount</i> .....	62
<i>Velocity Curve</i> .....	63
<i>Keyboard Center</i> .....	64
<i>Keyboard Tuning</i> .....	64
<i>Mix Output Assign</i> .....	65
<i>Preset Links</i> .....	65
<i>Save Preset</i> .....	66
<b>PRACTICE PROGRAMMING</b> .....	<b>67</b>
<i>Linking Presets</i> .....	69
<i>Editing Presets</i> .....	70
<i>Changing the Tuning of an Instrument</i> .....	70
<i>Chorus</i> .....	71
<i>Reversing an Instrument</i> .....	71
<i>Alternate Volume Envelope</i> .....	72
<i>Working with the Filter</i> .....	73
<i>Vintage Synthesis</i> .....	77
<i>Reverb Spaces</i> .....	78
<i>Using Vintage Keys with a Sequencer</i> .....	79
<i>More Advanced Sequencing</i> .....	80
<b>REFERENCE SECTION</b> .....	<b>83</b>
<i>Preset Listing</i> .....	84
<i>Instrument Listing</i> .....	88
<i>B3 Waves - Drawbar Settings</i> .....	95
<i>Percussion Instrument Locations</i> .....	98
<i>Technical Specifications</i> .....	101
<i>MIDI Specifications</i> .....	102
<i>Warranty</i> .....	118
<i>Index</i> .....	119





---

# **INTRODUCTION**

---

# **INTRODUCTION & BASIC SETUP**





## WHAT'S A VINTAGE KEYS?

Vintage Keys is a musical instrument whose sounds are based on digital recordings of the classic keyboards of yesteryear. But despite the name, Vintage Keys is not strictly limited to vintage sounds. The vintage keyboard samples are simply the starting point for you to take off in any direction.

To begin with, Vintage Keys contains eight megabytes (internally expandable to 16 megabytes) of the highest quality 16 bit samples selected from the Emulator III sound library and stored in ROMs for instant access. You now have virtually every major keyboard ever made beneath your fingers. These sounds have been used on literally thousands of hit recordings over the years. They're all here, without recording problems, unreliability and the hassles of moving heavy equipment.

Vintage Keys gives you the ability to literally take the sounds apart and reassemble them into a limitless number of entirely new sounds, combining parts of one sound with another or with any of a selection of digital waveforms also stored in ROM. For example, the attack of a flute can be faded out as a vocal pad is faded in, giving you a completely new sound! The dynamic 2 and 4 pole filters allow you to shape and mold your sound in order to exactly duplicate classic synthesizer sounds. The 16 bit samples are arranged into 512 preset locations, 256 of which are user-programmable.

Vintage Keys also features 32 voice polyphony allowing you to take full advantage of its layering capabilities (up to 8 sounds on each key) and its ability to respond multi-timbrally to all 16 MIDI channels makes it ideally suited for multitrack sequencing and composing using a MIDI sequencer.

Other features include 3 stereo outputs for individually processing sounds (also configurable as 6 polyphonic submixes with fully programmable panning), integral sends and returns to allow the addition of external effects units without the need for a separate mixer, user definable alternate tuning, and of course, an extensive MIDI implementation.

Vintage Keys is organized as shown in the diagram below.

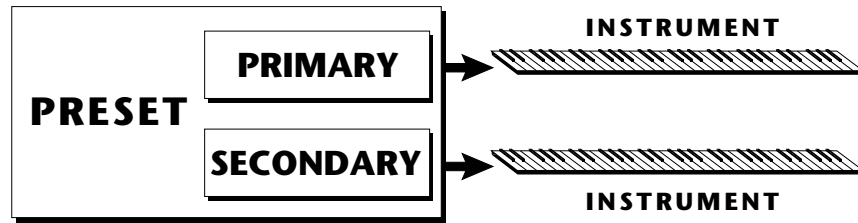

The *Preset* is a complete set of all program parameters for a complete Vintage Keys sound. The fully programmable user presets and the unalterable ROM presets are organized as shown below.



- **User Presets** can be moved, erased or modified as desired.
- **ROM Presets** cannot be moved or altered unless they are first copied to a user location.

Each preset consists of one or more instruments. An instrument is a complete set of samples or a digital waveform which covers the entire keyboard range. An instrument can be assigned to each of the *Primary* and *Secondary* layers of the preset.

The primary and secondary layers are essentially two complete sounds stacked or placed adjacent to each other, and can be switched or crossfaded together in various ways.

Up to four presets can be *Linked* in order to have more than one preset on the keyboard at a time. The linked presets may overlap each other for layered sounds or be adjacent to each other to create keyboard “splits”.

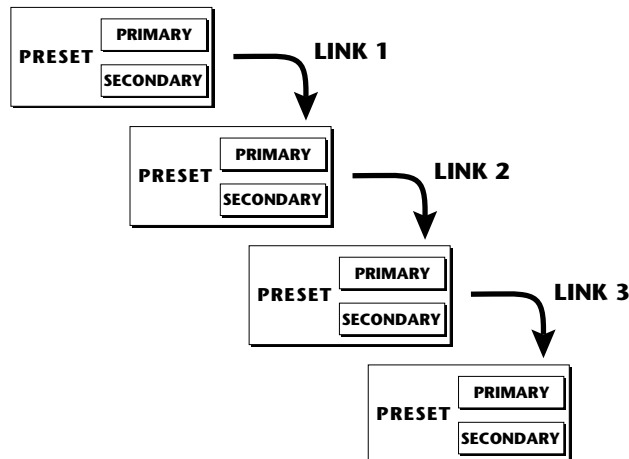

SETUP #1 BASIC SETUP

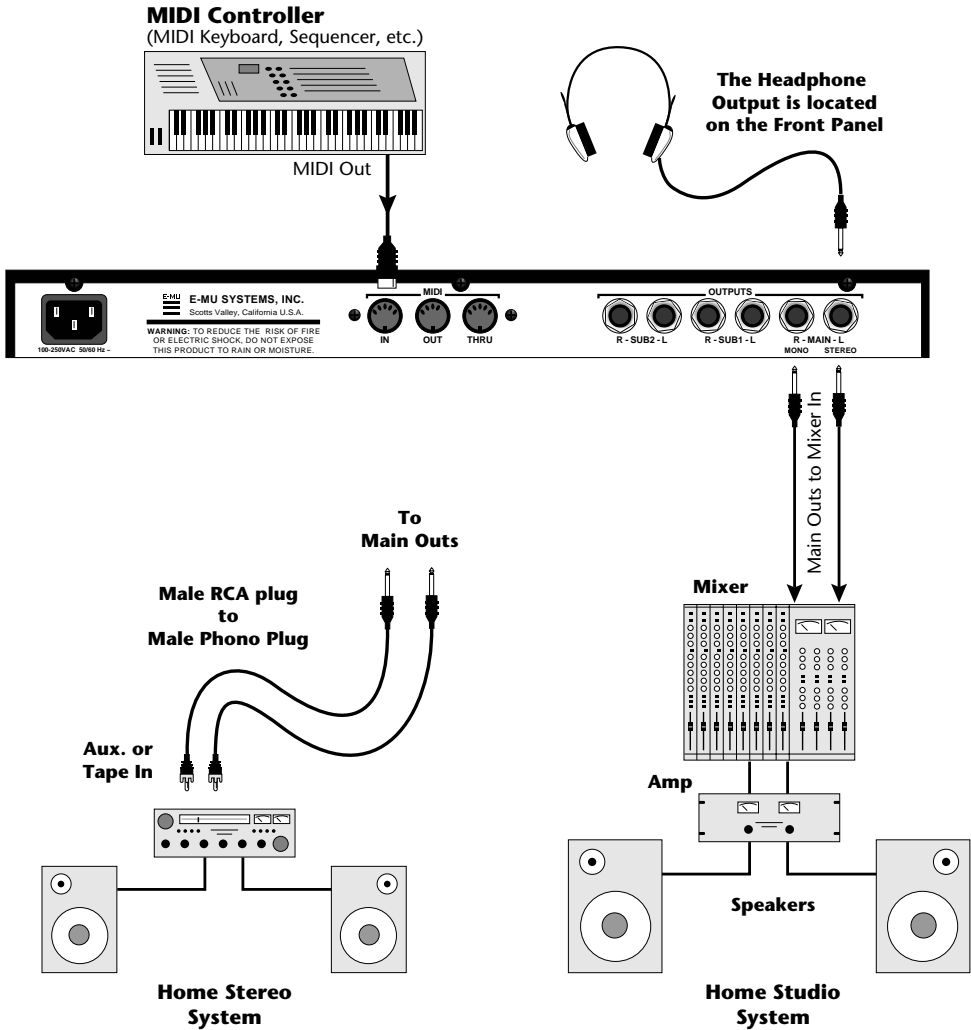

▼ The headphone output monitors the main outputs only. The submix outputs do NOT feed into the headphone output.

••• If Vintage Keys does not seem to be responding correctly, make sure the both Vintage Keys and your MIDI controller are set to the same MIDI channel.

**MIDI In**

Vintage Keys is controlled by MIDI messages received at the MIDI In connector. Connect the MIDI In of the Vintage Keys to the MIDI Out connector of a MIDI controller such as a MIDI keyboard, MIDI wind controller or MIDI guitar controller.

**Outputs**

Vintage Keys is a high quality, stereo audio device. In order to reproduce its wide dynamic range and frequency response, use a high quality amplification and speaker system such as a keyboard amplifier or home stereo system. A stereo setup is highly desirable because of the added realism of stereophonic sound. Headphones can be used if an amplifier and speaker system is not available. Plug stereo headphones into the headphone jack located on the left side of the front panel. The Right Main output jack serves as a mono output when the Left Main plug is not plugged in.

## SETUP #2 STUDIO SETUP

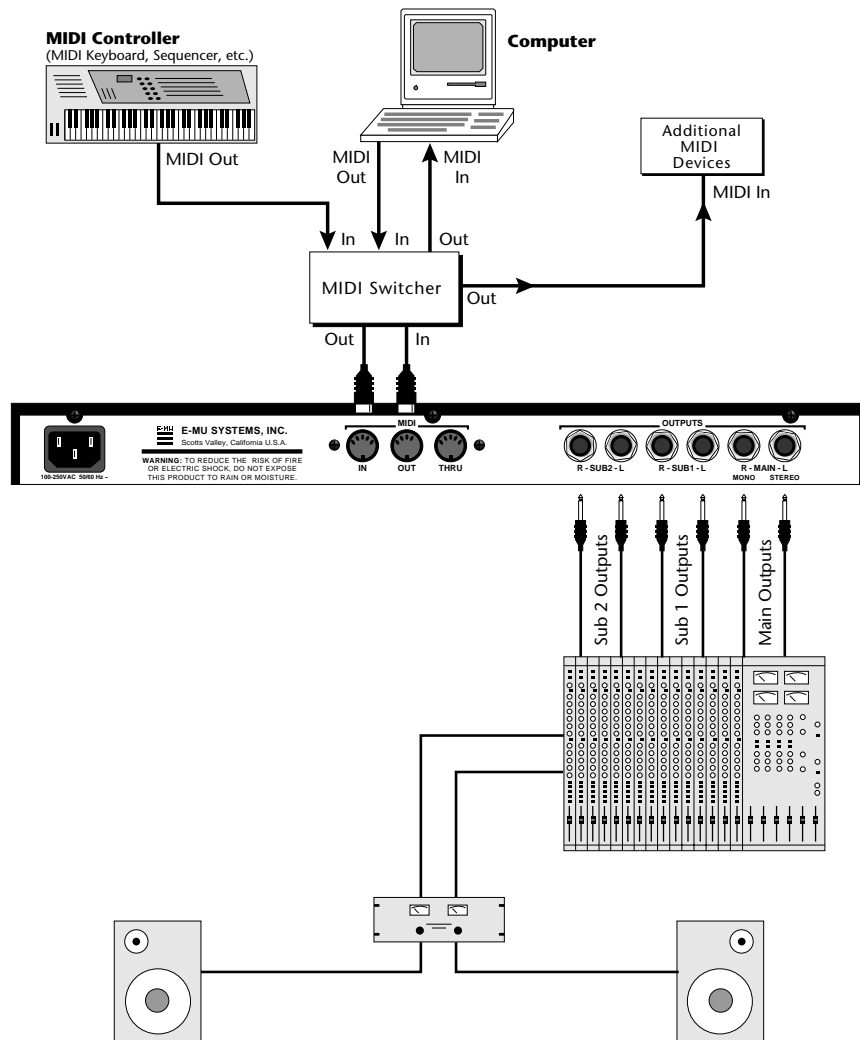

### **MIDI In**

In this setup, Vintage Keys is controlled by MIDI messages received at the MIDI In connector which have been routed by a MIDI switcher. The MIDI switcher allows any MIDI controller such as a MIDI keyboard, MIDI wind controller or a computer to be easily connected.

### **MIDI Out**

The MIDI Out jack is normally used to transmit program data to a computer or other device.

### **Outputs**

Vintage Keys has three sets of programmable stereo outputs; Main, Sub 1, and Sub 2. Specific Vintage Keys presets (or MIDI channels) can be routed to one of these stereo pairs in order to be further processed or mixed separately.

### SETUP #3 PERFORMANCE SETUP

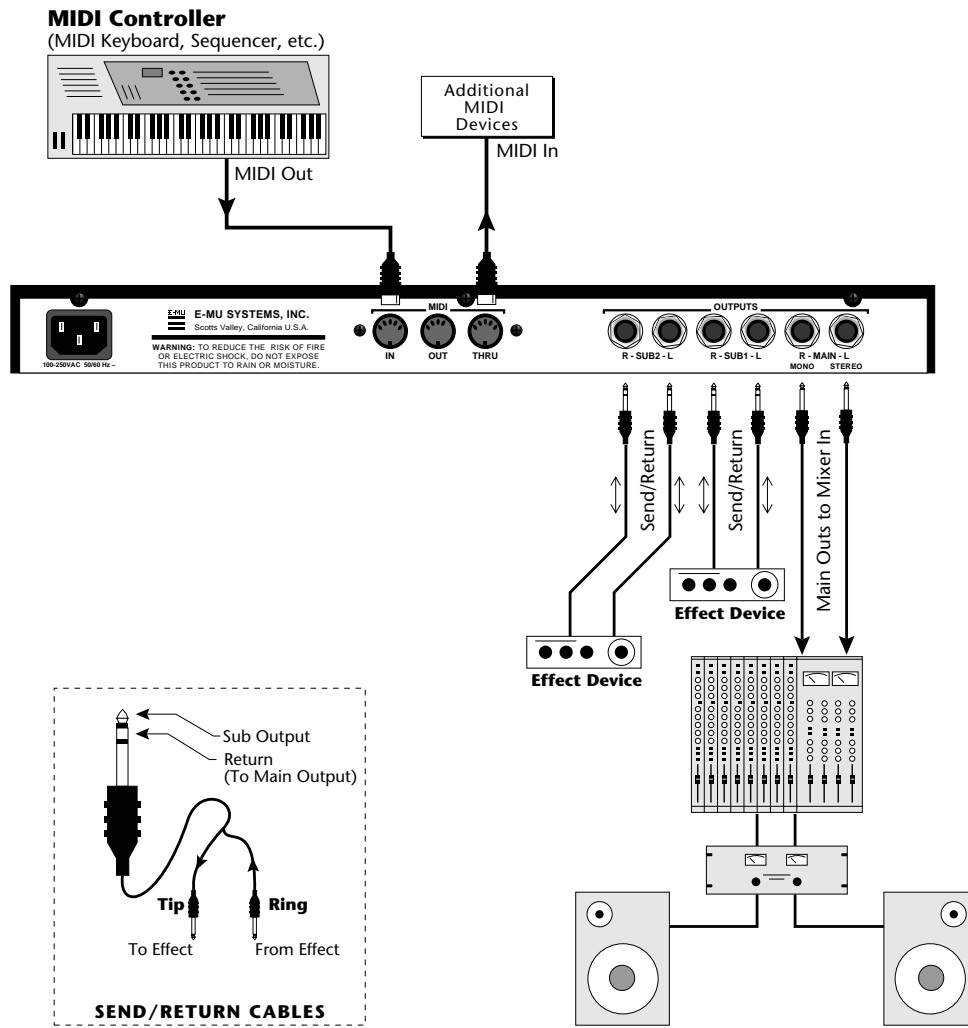

#### MIDI In

Vintage Keys is controlled by MIDI messages received at the MIDI In connector. Connect the MIDI In of Vintage Keys to the MIDI Out connector of a MIDI controller such as a MIDI keyboard, MIDI wind controller or MIDI guitar controller.

#### MIDI Thru

The MIDI Thru jack is used to connect additional MIDI devices onto the MIDI chain. MIDI Thru transmits an exact copy of the messages received at the MIDI In jack.

#### Outputs

Each of the Sub 1 and Sub 2 output jacks on the Vintage Keys are stereo jacks. The tip of each jack (accessed when a standard phone plug is inserted) connects to the left or right output of that group.



••• Inserting a standard mono phone plug **halfway** into the jack allows you to sum into the main outputs without a special cable.

If a stereo plug is inserted, the Ring of the stereo plug serves as a signal Return which sums into the Main outputs.

*Therefore, the Sub 1 and Sub 2 jacks can serve as effect sends and returns in order to further process selected instruments and then return them to the main mix.*

The diagram shows the Sub 1 and Sub 2 jacks being used as send/returns in order to further process selected Vintage Keys presets without using the effects bus on the mixing board. In a pinch, the effect returns could also be used to sum additional instruments into the main outputs.

### Vintage Keys Output Section

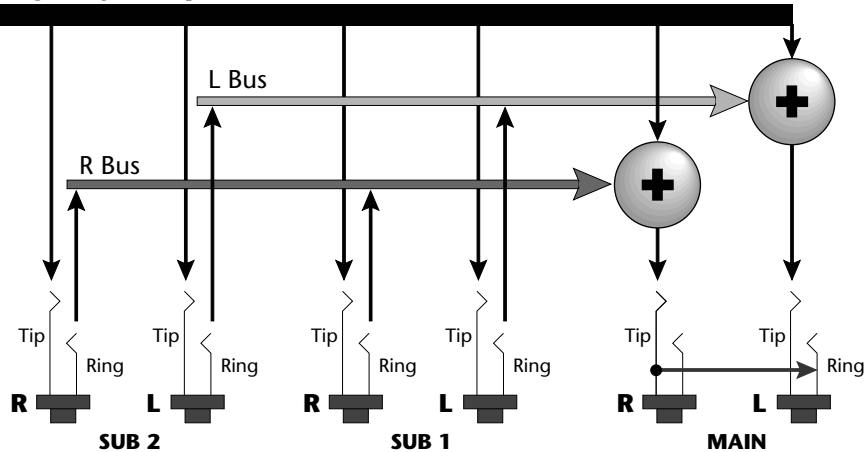

The Sub 1 and Sub 2 jacks can be used as effect returns to the Main Outputs.

### POWER UP!

The power switch is located on the right side of the front panel. Vintage Keys and its MIDI controller may be turned on in any order. When power is applied, the liquid crystal display will light, indicating that Vintage Keys is operating. You may have noticed that there is no 110/220 Volt power selector switch on Vintage Keys.

**Vintage Keys automatically switches itself for 110 or 220 Volt operation.**

---

**BASIC  
OPERATION**



## MAIN CONTROLS

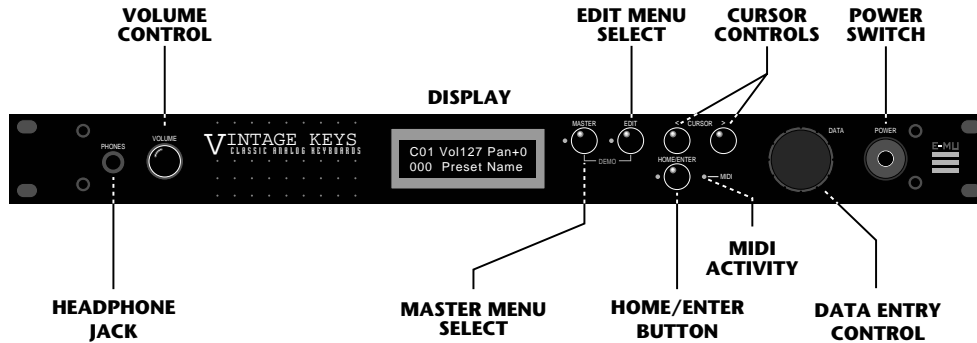

### **Power Switch**

Switches AC power to Vintage Keys On and Off.

### **MIDI Activity LED**

Indicates that MIDI data is being received.

### **Master Menu Select Button**

The Master menu contains parameters that affect the entire machine, not just certain presets. An illuminated LED to the left of the button indicates that you are in the Master menu.

### **Edit Menu Select Button**

The Edit menu is used when you want to change parameters of a preset. An illuminated LED to the left of the button indicates that you are in the Edit menu.

### **Home/Enter Button**

The Home/Enter button is used to initiate a particular operation. The red LED to the left of the enter button flashes to let you know that Vintage Keys is waiting for your response.

### **Cursor Control**

This button moves the cursor to the next parameter on the display. (The cursor is a little flashing line underneath one of the parameters in the display.) Press the cursor control repeatedly until the cursor is underneath the desired parameter. The cursor can also be moved bidirectionally using the data entry control while the cursor select button is being held down (i.e. Press and hold the cursor button and turn the data entry knob).

### **Data Entry Control**

The data entry control is a stepped, variable control which is used to change parameter values. The control increments or decrements the current value one unit with each click. This control incorporates acceleration (values advance faster if the control is turned quickly).

### **Volume Control**

This is the master volume control for all audio outputs. Note: For maximum dynamic range, set this control at full level.

## MIDI CHANNEL SELECTION

Press the cursor key repeatedly until the cursor is underneath the channel number. (The cursor is a little flashing line underneath one of the parameters in the display.) Rotate the data entry control to select MIDI channel 01-16. As the channel is changed, the display will change to show the preset, volume and pan associated with the displayed channel.

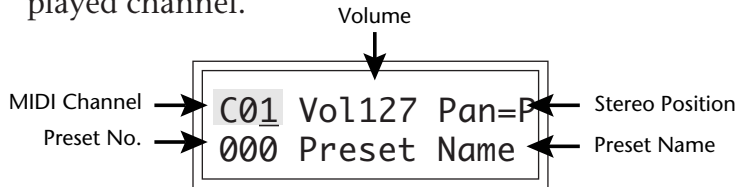

••• If Vintage Keys is not responding properly or plays the wrong preset, make sure that both Vintage Keys and your MIDI controller are set to the same MIDI channel and that the MIDI Volume is turned up.

For more information about MIDI, see MIDI Realtime Controls on page 40.

## PRESET SELECTION

Press the cursor key repeatedly until the cursor is underneath the preset number. (The cursor is a little flashing line underneath one of the parameters in the display.) As the data entry control is rotated, the preset number and name will change. The displayed preset will be assigned to the displayed MIDI channel. Preset numbers range from 000 to 511.

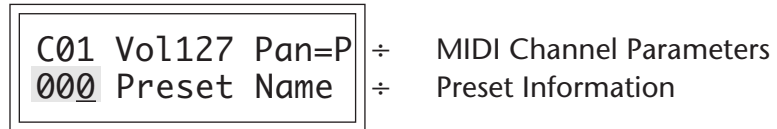

## CHANNEL VOLUME

Press the cursor key repeatedly until the cursor is underneath the volume value. Rotate the data entry control to select volume 00-127. (This is the same parameter as MIDI volume control #7, and changes made over MIDI will be shown in the display.)

## CHANNEL PAN

Press the cursor key repeatedly until the cursor is underneath the pan value. Rotate the data entry control to select pan values -7 to +7 or "P". When "P" is selected, the pan value specified in the preset is selected. Any other value will override the pan parameter in the preset. (This is the same parameter as MIDI pan control #10, and changes made over MIDI will be shown in the display.)

••• Channel Pan should normally be set to "P" unless realtime control of panning is desired. This will allow the programmed pan setting for each preset to be used.

## PLAYING THE DEMO SEQUENCES

Vintage Keys contains a play-only sequencer in order to give you an idea of what is possible using this amazing machine. Press and hold both the Master button and the Edit button. The sequence will start in a moment. Press the Enter button to stop the sequence. Press either cursor button to change the sequence. Vintage Keys contains 4 sequences (1-4).

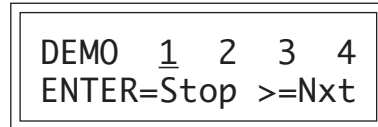

## MULTI-TIMBRAL OPERATION

Multi-timbral operation means that the Vintage Keys can play more than one sound at the same time. To access multiple presets on different MIDI channels simultaneously, follow these instructions:

1. Set the MIDI mode to MULTI-Mode, using the MIDI mode function in the Master menu (page 20).
2. Decide which MIDI channels you wish the Vintage Keys to receive, and turn all other channels OFF using the MIDI Enable function in the Master menu (page 21). *Up to 16 channels can be selected simultaneously!*
3. Select the desired preset for each of the MIDI channels you wish the Vintage Keys to receive using the MIDI Channel/Preset selection screen (see previous instructions).
4. Vintage Keys will now respond multi-timbrally on the MIDI channels you have specified. The volume and pan position parameters can be adjusted over MIDI (for each MIDI channel) or using the Cursor and Data Entry control in the MIDI Channel/Preset selection screen.

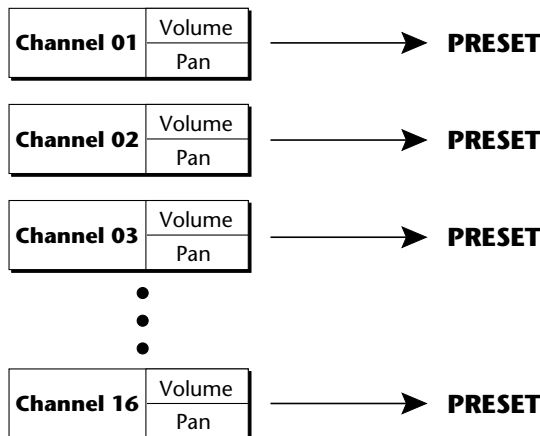

Each of the 16 MIDI channels can be assigned to play a specific Vintage Keys preset.

### ••• Demo Sequences

1. *Funky Blues & R+B Organ Demo - by Herb Jimmerson*
2. *Synth Rock Orchestra by Gary Hull*
3. *Techno Rave by Sean Wilhelmsen*
4. *Pop/Rock Medley by Will Puckett*

**ABOUT VINTAGE KEYS**

Vintage Keys utilizes digital recordings of real instruments for the basis of its sound. This is similar to a tape recorder except that inside the Vintage Keys, the sounds are permanently recorded on digital memory chips.

To perform this modern miracle, sounds and instrument waveforms are first sampled into the Emulator III, our top of the line, 16 bit stereo digital sampler. After the sounds and waveforms have been truncated, looped and processed, they are “masked” into the Vintage Keys ROM (Read Only Memory) chips.

Conceptually, the sampling process is very simple, as shown in the Basic Sampling System diagram. As a sound wave strikes the diaphragm of a microphone, a corresponding voltage is generated. To sample the sound, the voltage level is repeatedly measured at a very high rate and the voltage measurements are stored in memory. To play the sound back, the numbers are read back out of memory, converted back into voltages, then amplified and fed to a speaker which converts the voltage back into sound waves. Of course, playing back 32 channels at different pitches tends to complicate matters, but this is basically how it works. In Vintage Keys, we have left out the Analog/Digital converter stage since the sounds are already sampled for you.

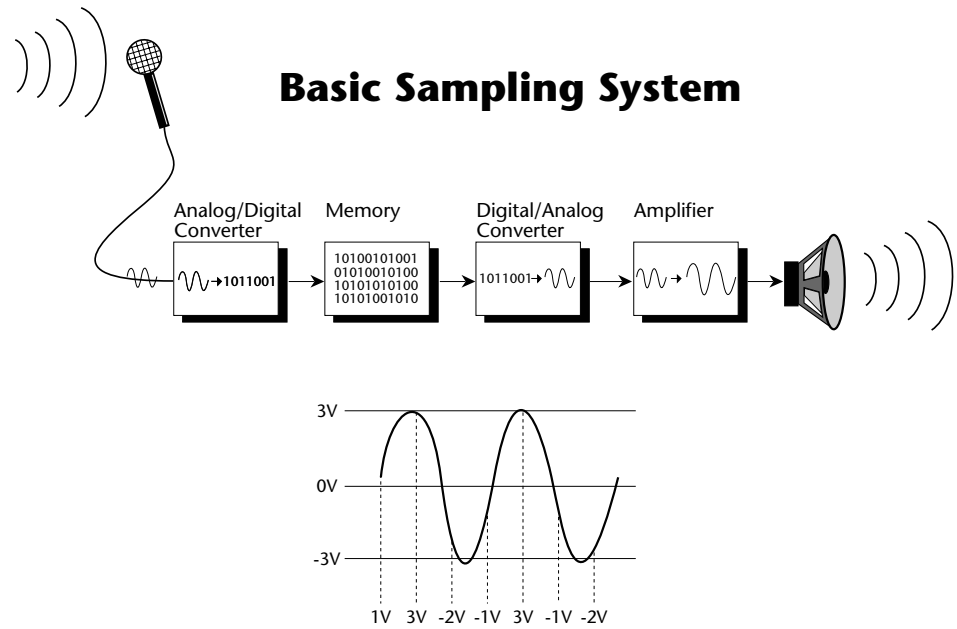



# MASTER MENU





The Master menu contains functions that affect the overall operation of Vintage Keys. For example, changing the Master Tune will change the tuning of all the presets, not just the one currently displayed.

***To enable the Master menu***

Press the Master key, lighting the LED. The current screen will be the one most recently selected since powering up Vintage Keys. The cursor will appear underneath the first character of the screen heading on line one.

***To select a new screen***

Press the cursor key repeatedly (or hold the cursor key while turning the data entry control) until the cursor is underneath the screen title heading. Rotate the data entry control to select another screen.

***To modify a parameter***

Press the cursor key repeatedly (or hold the cursor key while turning the data entry control) until the cursor is underneath the parameter value. Rotate the data entry control to change the value.

***To return to Preset Select mode***

Press the Master key, turning off the LED.

## MASTER MENU FUNCTIONS

• ***Master Tune***

Master Tune adjusts the overall tuning of all presets so that Vintage Keys can be tuned to other instruments. The master tuning range is  $\pm 1$  semitone in 1/64th semitone increments. A master tune setting of "00" would indicate that the Vintage Keys is perfectly tuned to concert pitch (A=440 Hz).



MASTER TUNE  
+63

- **Transpose**

This function transposes the key of Vintage Keys in half-step intervals. The transpose range is  $\pm 12$  semitones or one octave.

TRANSCOPE  
+12 semitones

- **Global Bend**

This function sets the range of the pitch wheel *only* when it is routed to control pitch. The maximum pitch bend range is  $\pm 12$  semitones. This function only affects presets which have their individual pitch bend range set to global.

GLOBAL BEND  
+/- 12 semitones

- **Global Velocity Curve**

Incoming velocity data can be modified by a velocity curve in order to provide different types of dynamics in response to your playing or to better adapt to a MIDI controller. This function allows you to select one of eight global velocity curves or leave the velocity data unaltered (off). Global velocity curve only affects presets which have their individual velocity curve set to global.

GLOBAL VEL CURVE  
8

GLOBAL VELOCITY CURVES

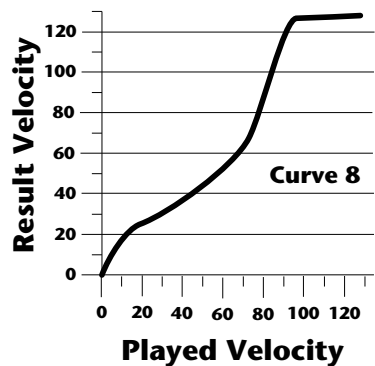
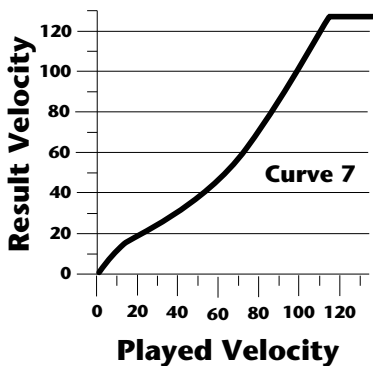
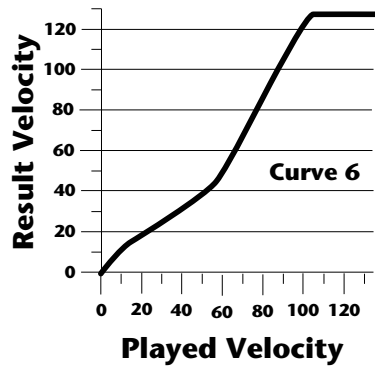
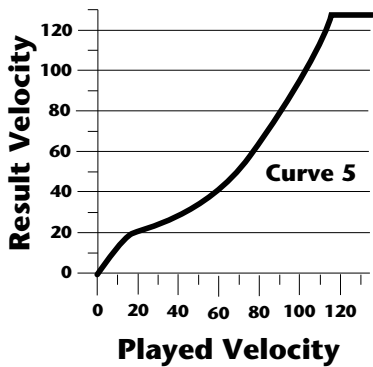
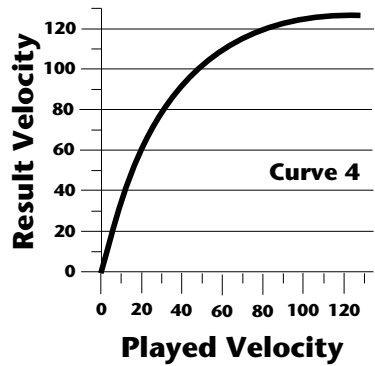
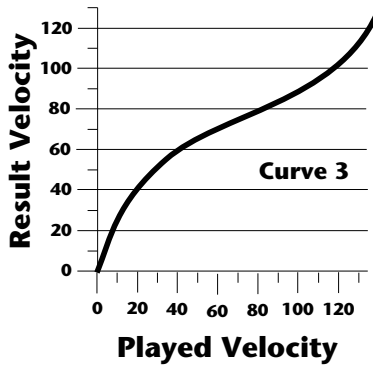
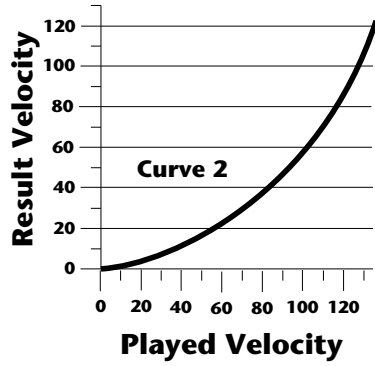
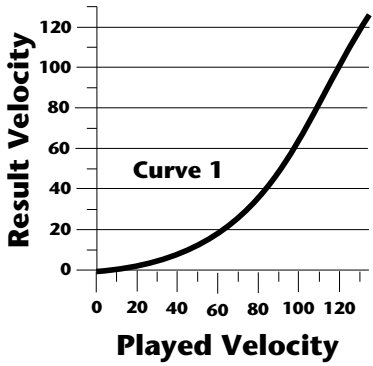

••• This function is useful when sequencing because it allows you route specific MIDI channels to the Submix outputs. From there they can be externally processed with reverb or other effects.

## • **Mix Output**

This function allows you override the output assignments made in each preset and instead assign the outputs according to MIDI channel. This also allows you to change the output assignment of the factory presets. For each of the 16 MIDI channels, you can select the Main, Sub 1, or Sub 2 outputs, or “P”. When “P” is selected, the output assignment selected in the preset is used. If no plugs are inserted into the sub outputs, the audio will be automatically directed to the main outputs.

MIX OUTPUT channel 01:P
----------------------------

## • **MIDI Mode**

This function selects one of the four MIDI modes and the MIDI system exclusive ID number.

### **Omni mode**

Vintage Keys responds to note information on all MIDI channels and plays the preset currently displayed in the main screen.

### **Poly mode**

Vintage Keys only responds to note information received on the currently selected MIDI channel (on the preset selection screen) and plays that channel’s associated preset.

### **Multi mode**

Vintage Keys responds to data on any combination of MIDI channels and plays the specific preset associated with each of the MIDI channels.

### **Mono mode**

Vintage Keys responds to data on any combination of MIDI channels but plays each channel monophonically. If a new note on a channel is played before the last note is released, the envelopes will not be retriggered (legato). Mono mode is particularly useful with alternate controllers such as MIDI guitars, etc.

### **ID number**

This function allows an external programming unit to distinguish between multiple Vintage Keys units. In the case of multiple Vintage Keys units, each unit should have a different ID number.

MIDI MODE	ID
Omni	00

▼ **Warning:** Presets will not be transferred between two Vintage Keys units unless the ID numbers of both units match.

- **MIDI Mode Change**

This function selects whether or not MIDI mode change commands are accepted or ignored when received over MIDI (see MIDI Mode).

MIDI MODE CHANGE  
Disabled

- **MIDI Overflow**

When on, if you play more notes than Vintage Keys has channels (32), the additional note data will be directed out the MIDI Out port to a second Vintage Keys or other MIDI device, thus doubling the number of available channels. MIDI Overflow can be turned On or Off.

MIDI OVERFLOW  
Off

- **MIDI Enable**

When in MIDI Multi mode, this function lets you turn each MIDI channel On or Off. This is useful when you have other MIDI devices connected and do not want the Vintage Keys to respond to the MIDI channels reserved for the other devices. MIDI Enable only operates in Multi Mode.

MIDI ENABLE  
channel:01 On

- **Preset Change**

This function lets the Vintage Keys utilize or ignore incoming MIDI preset change commands for each channel. Note that MIDI can only select presets 000-127. Presets 128-511 can either be selected manually or over MIDI using the mapping function “MIDI PROGRAM → PRESET”.

PRESET CHANGE  
channel:01 On

••• **A few of the standardized MIDI Controller numbers are listed below.**

- 1 - Modulation Wheel or Lever
- 2 - Breath Controller
- 3 - Aftertouch: Rev 1 DX7
- 4 - Foot Pedal
- 5 - Portamento Time
- 6 - Data Entry
- 7 - Volume
- 8 - Balance
- 9 - Undefined
- 10 - Pan
- 11 - Expression

••• **A few of the standardized MIDI switch numbers are listed below.**

- 64 - Sustain Switch (on/off)
- 65 - Portamento (on/off)
- 66 - Sostenuato (on/off)
- 67 - Soft Pedal (on/off)
- 69 - Hold Pedal 2 (on/off)

• **MIDI Controller Assign**

Vintage Keys allows you to assign up to four realtime control sources from your MIDI controller. These control sources could be modulation wheels, data sliders or whatever. In this screen, you set up which controllers will be received by the Vintage Keys. What effect the controller will have is programmed separately for each preset. The Vintage Keys MIDI controllers are each assigned a letter, A-D. Each controller letter can be assigned to a MIDI realtime controller from 01-31. Note: If controller numbers 7 or 10 are selected, they will override the standard MIDI volume and pan control routings. For more information, see MIDI Realtime Controls in the Programming Basics section.



• **MIDI Footswitch Assign**

Like the MIDI Controllers, 3 MIDI footswitches can be assigned to MIDI footswitch numbers. Footswitches can be assigned numbers from 64-79. Destinations for the footswitch controllers are programmed in the Edit menu.

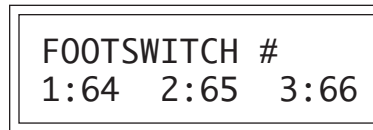

• **MIDI Program → Preset**

Incoming MIDI program changes can be “mapped” to call a different numbered preset. This is a handy feature when you want a specific preset number sent from the master synth to be linked with a specific preset on Vintage Keys. For example, the Program → Preset Map could be set to call up preset 12 whenever Vintage Keys receives program change number 26. Any of the presets in Vintage Keys can be mapped to any incoming MIDI program change number. This feature also allows you to call up the presets 128-511, which are not normally accessible over MIDI.

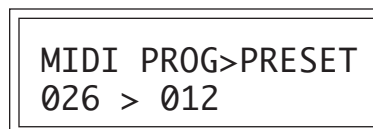

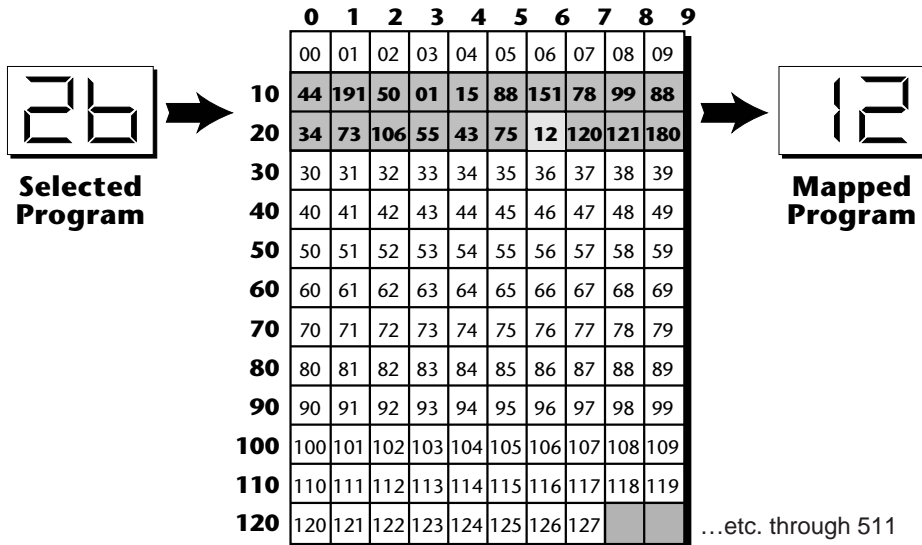

This chart shows how MIDI preset changes can be re-mapped. In this example, program changes 10-29 have been re-mapped. All other programs will be selected normally.

• **Send MIDI Data**

This function will send MIDI System Exclusive data to the MIDI Out port of Vintage Keys. The MIDI data can either be sent to a computer/sequencer or to another Vintage Keys. Using the cursor key and the data entry control, select the type of MIDI data you wish to transmit. The choices are:

**Master Settings**

Transmits all parameters in the Master menu except tuning table, program/preset map and viewing angle.

**Program/ Preset Map**

Transmits only the program/preset map.

**Tuning Table**

Transmits only the user tuning table.

**Factory Presets**

Transmits all the factory ROM presets.

**User Presets**

Transmits all the user presets.

**Any Individual Preset**

Transmits only the selected preset.

The Enter LED will be flashing. Press the Enter button to confirm the operation. To receive MIDI data, simply send the MIDI data into Vintage Keys from another Vintage Keys or your sequencer.



**To Record MIDI Data into a Sequencer:**

1. Setup sequencer to receive system exclusive data.
2. Place sequencer into record mode, then Send Preset Data.

**To Receive MIDI Data from a Sequencer:**

1. Simply play back the sequence into Vintage Keys.

▼ **Warning:** Send data as you would a regular sequence. Sending data in one huge chunk may clog the Vintage Keys input buffer.

••• The Preset, Volume, and Pan information for all 16 channels is included when the Master settings are transmitted or received.

▼ **Warning:** When transferring SysEx data from one Vintage Keys to another, the ID numbers of both units must match.



••• **Application:** *The user key tuning can be used to tune individual percussion instruments.*

## • **User Key Tuning**

In addition to standard twelve tone equal temperament, Vintage Keys contains four additional preset tuning tables (Just C, Vallotti, 19 tone, and Gamelan) and one user definable tuning. User Key Tuning allows you to alter the parameters of the user definable tuning stored in memory. The initial frequency of every key can be individually tuned, facilitating the creation of microtonal scales. Using the cursor key and the data entry control, select the key name, the MIDI key number and the fine tuning. The key name is variable from C-2 to G8. MIDI key number is variable from 0 to 127. The fine tuning is variable from 00 to 63 in increments of 1/64 of a semitone (approx. 1.56 cents). For each preset, the specific tuning table is selected in the Edit menu.

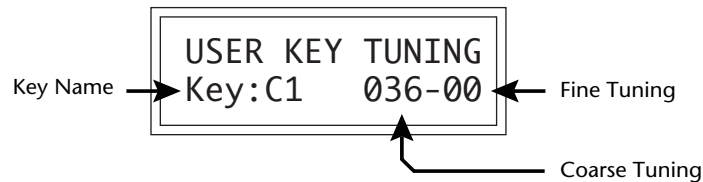

## • **Viewing Angle**

This function allows you to change the viewing angle of the display so that it may be easily read from either above or below. The angle is adjustable from +7 to -8. Positive values will make the display easier to read when viewed from above. Negative values make the display easier to read from below.



---

---

# **PROGRAMMING BASICS**



This chapter explains how Vintage Keys sounds are constructed and contains important background information on how to create your own custom presets.

Your initial involvement with Vintage Keys will most likely consist of using the existing presets and selecting MIDI channels. While the factory presets are very good, there are probably some things you would like to change, perhaps the LFO speed, the filter cutoff or the attack time. You may also want to make your own custom presets using complex modulation routings. There are 256 user locations (000-255) available to store your own creations or edited factory presets. Best of all, it's easy to edit or create new presets using the edit menu.

Presets can be made up of both a primary and secondary instrument. Presets can also be "linked" with up to 3 additional presets to create layering or splits.

One way to create a keyboard split is assign an instrument to a specific range and then link it to other presets which fill in the empty keys. Using a combination of 4 linked presets and the primary and secondary instrument ranges, up to 8 keyboard splits can be produced. If linked presets overlap on the same keyboard range, the presets will be doubled or stacked.

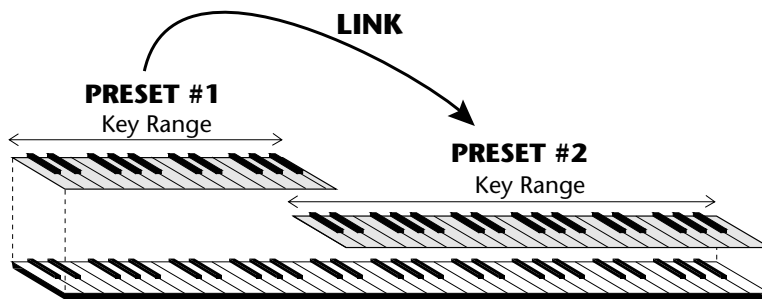

**CREATING A SPLIT KEYBOARD**

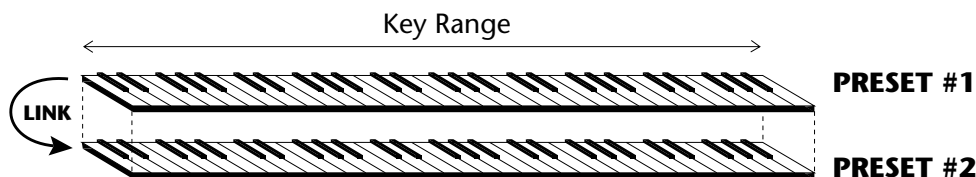

**LAYERING TWO PRESETS**

*These diagrams show how keyboard splits and layers can be created by linking presets. Remember that each preset can consist of both a primary and secondary instrument.*

Vintage Keys has an extensive modulation implementation using two multi-wave LFO's (Low Frequency Oscillators), two envelope generators and the ability to respond to multiple MIDI controllers. You can simultaneously route any combination of these control sources to multiple destinations.

### MODULATION

Modulation means to *dynamically change* a parameter, whether it be the volume (amplitude modulation), the pitch (frequency modulation), or whatever. Turning the volume control on your home stereo rapidly back and forth would be an example of amplitude modulation. To modulate something we need a modulation *source* and a modulation *destination*. The source is your hand turning the knob, and the destination is the volume control. If we had a device that would automatically turn the volume control, we would also call that device a modulation source. The Vintage Keys is designed so that for each of the variable parameters, such as the volume, there is an initial setting which can be changed by a modulation source. Therefore in the case of volume, we have an initial volume and we can change or modulate that volume with a modulation source. Two main types of modulation sources on Vintage Keys are *Envelope Generators* and *Low Frequency Oscillators*. In the example above, an envelope generator could be routed to automatically turn the volume control as programmed by the envelope. Or, a low frequency oscillator could be routed to automatically turn the volume control up and down in a repeating fashion.

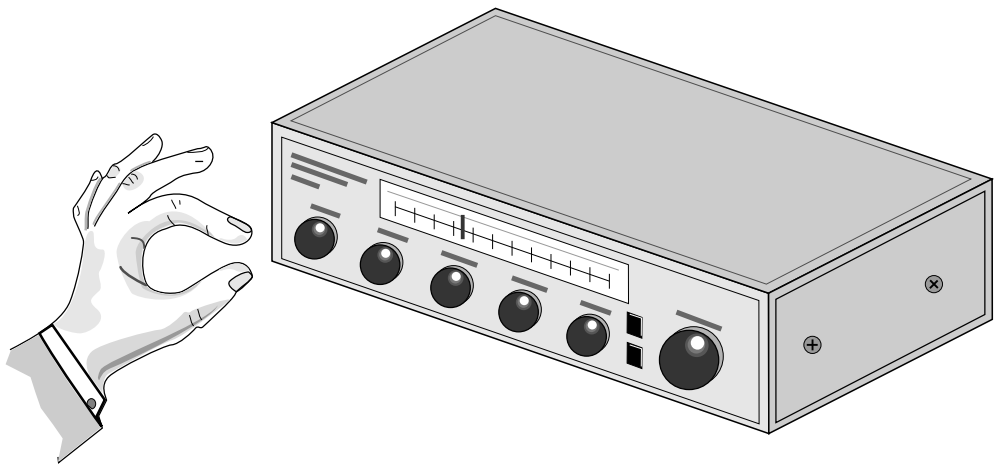

*Turning the volume control back and forth on your home stereo is an example of Amplitude Modulation.*

## MODULATION SOURCES

Vintage Keys uses three kinds of modulation sources.

### • KEYBOARD AND VELOCITY MODULATION

Values which are generated at the start of a note and do not change during the note.

#### *Keyboard Key*

Which key is pressed.

#### *Key Velocity*

How hard the key is pressed.

### • REALTIME MODULATION

Values which can be continuously changed during the entire duration of the sound.

#### *Pitch Wheel*

A synthesizer pitch bend wheel.

#### *Miscellaneous Controllers (4)*

Any type of MIDI controller data.

#### *Keyboard Pressure (mono aftertouch)*

Key pressure applied after the key is initially pressed.

#### *Polyphonic Key Pressure*

Pressure from a controller capable of generating polyphonic pressure data.

#### *Low Frequency Oscillators (2)*

Generate repeating waves.

#### *Envelope Generators (2)*

Generate a programmable “contour” which changes over time when a key is pressed.

### • FOOTSWITCH MODULATION

Changes a parameter when one of the three footswitches are pressed. The footswitches can be programmed to switch: Sustain (pri/sec/both), Alternate Volume Envelope (pri/sec/both), Alternate Volume Release (pri/sec/both), or Cross-Switch between the primary and secondary instruments.

## ENVELOPE GENERATORS

An envelope can be described as a “contour” which can be used to shape the sound in some way over time. Each channel of the Vintage Keys contains two envelope generators. One of the envelope generators, the Alternate Volume Envelope, controls the volume of the primary or secondary instrument over time and has 5 stages, Attack, Hold, Decay, Sustain, and Release. The other envelope, the Auxiliary Envelope, can be routed to any realtime control destination and is a general purpose envelope. The Auxiliary Envelope has 6 stages: Delay, Attack, Hold, Decay, Sustain, and Release. The time of each stage can be adjusted to create myriad envelope shapes, which in turn shape the sound. The Envelope parameters can be described as follows:

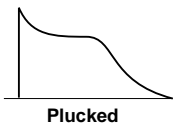
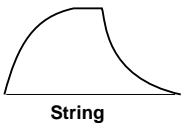
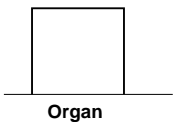
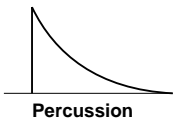

••• The generalized envelope shapes of a few types of sounds are shown above.

- **Delay**  
The time between when a key is played and when the attack phase begins.
- **Attack**  
The time it takes to go from zero to the peak (full) level.
- **Hold**  
The time the envelope will stay at the peak level before starting the decay phase.
- **Decay**  
The time it takes the envelope to go from the peak level to the sustain level.
- **Sustain**  
The level at which the envelope remains as long as a key is held down.
- **Release**  
The time it takes the envelope to fall to the zero level after the key is released.

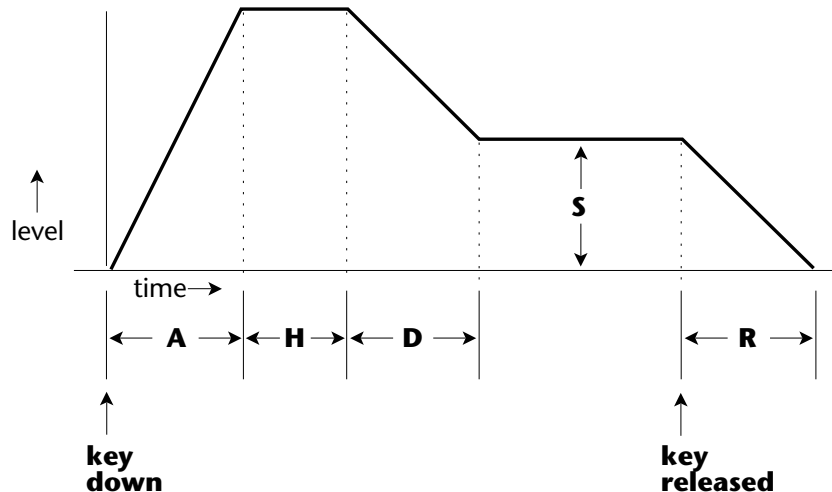

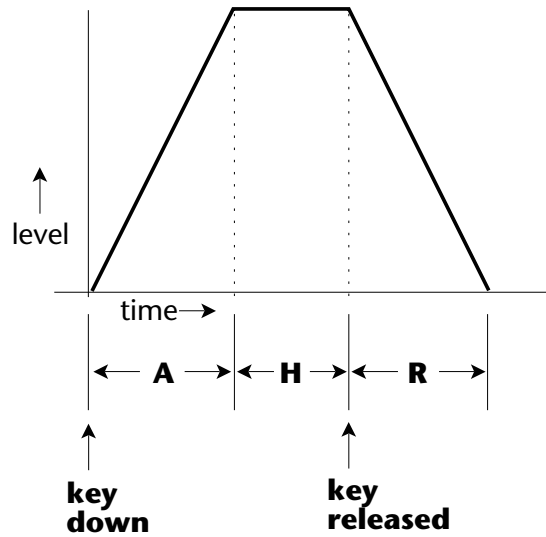

*If the key is released during the Hold (H) phase, the Release phase begins.*

### LOW FREQUENCY OSCILLATORS (LFOS)

A Low Frequency Oscillator is simply a wave which repeats at a slow rate. The Vintage Keys has two multi-wave LFOS for each of its 32 channels. The LFO waveforms are: Triangle, Sine, Square, Sawtooth, and Random, which is a random “sample and hold” type of wave.

By examining the diagram of the LFO waveforms, you can see how the LFO will affect a modulation destination. Suppose we are modulating the pitch of an instrument. The sine wave looks smooth, and will smoothly change the pitch. The square wave changes abruptly, and will abruptly change the pitch from one pitch to another. The sawtooth wave smoothly decreases, then abruptly changes back up. The sound’s pitch will follow the same course. Controlling the pitch of an instrument is an easy way to hear the effects of the LFO waves.

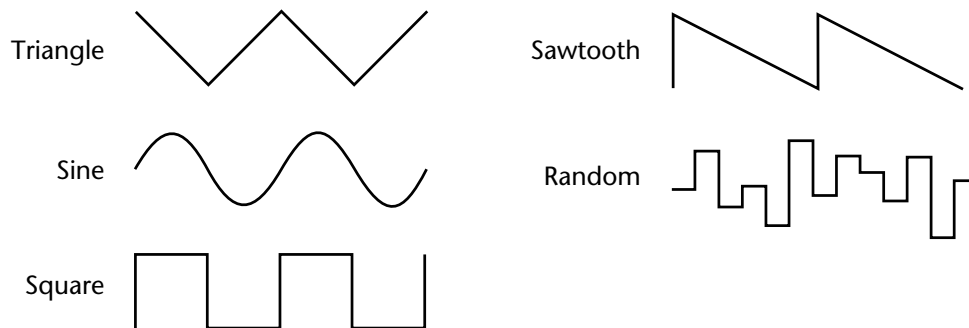



When the amount of an LFO is a negative value, the LFO shape will be inverted. For example, inverting the sawtooth wave produces a wave that smoothly increases, then instantly resets down.

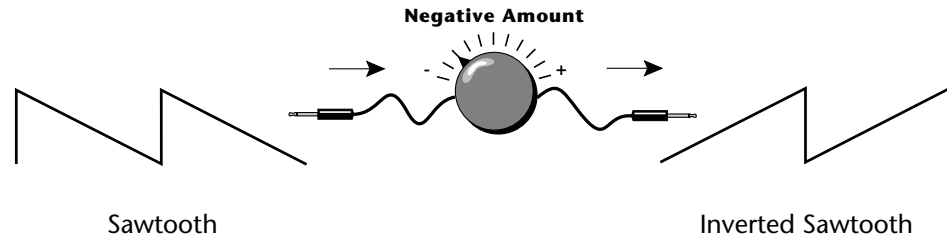

## MIDIPATCH

Connecting a modulation source to a destination is called a *patch*. Vintage Keys lets you connect the modulation sources in almost any possible way to the modulation destinations. You can even modulate other modulators. Each patch also has an amount parameter which determines “how much” modulation is applied to the destination. The modulation amount can be positive or negative and will either add or subtract from the initial value. Keyboard and velocity sources can be simultaneously patched to any 6 of the 42 destinations for each preset. Realtime modulation sources can be simultaneously patched to any 8 of the 30 destinations for each preset.

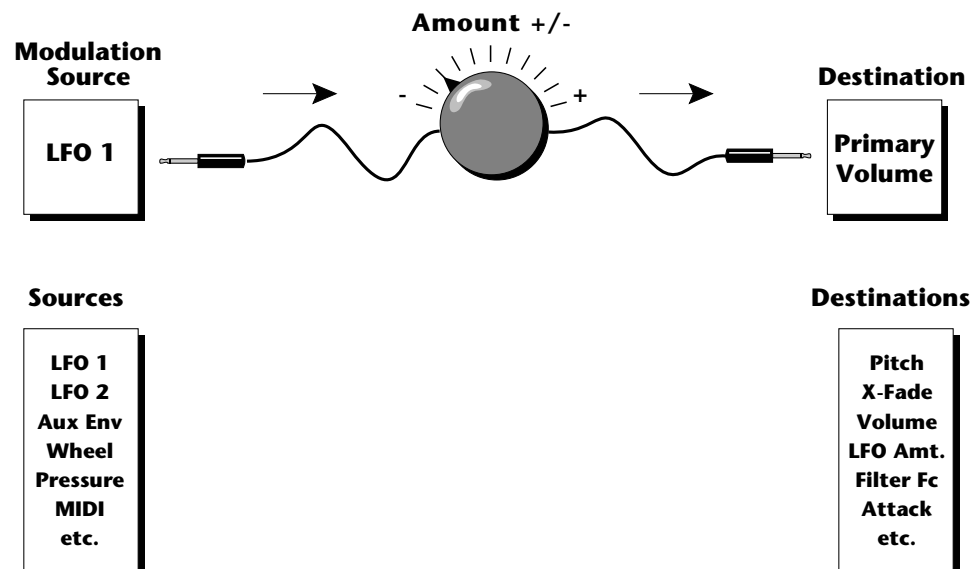

## FILTER MODULATION

Vintage Keys contains two low pass filters for each of its 32 channels. The block diagram of a single channel is shown below.

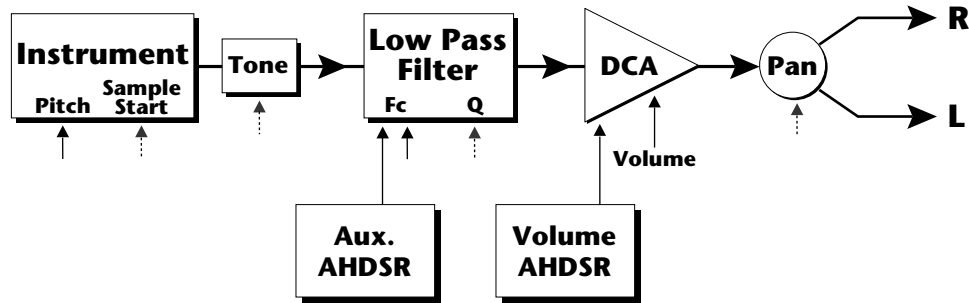

The **Tone** filter is a simple tone control and can be used to brighten or darken the tone of an instrument. The **Low Pass** filter is a powerful synthesizer filter which can dramatically alter the sound of an instrument.

## WHAT IS A FILTER?

To understand how a filter works we need to understand what makes up a sound wave. A sine wave is the simplest form of sound wave. Any waveform except a sine wave can be analyzed as a mix of sine waves at specific frequencies and amplitudes.

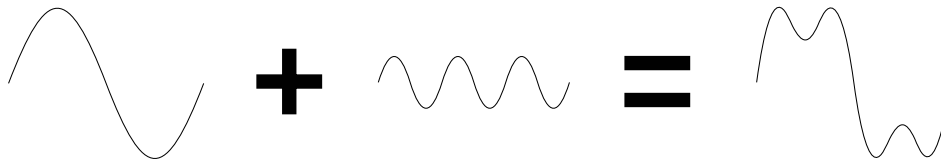

One way to represent complex waveforms is to use a chart with frequency on one axis and amplitude on the other. Each vertical line of the chart represents one sine wave at a specific amplitude.

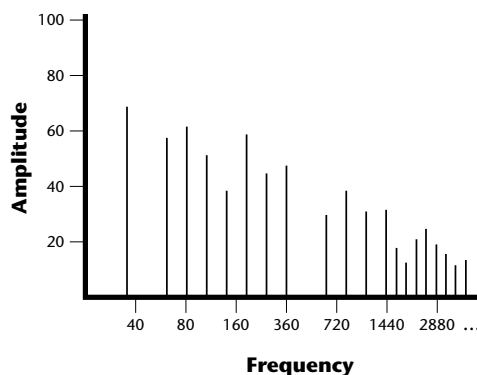

Most of the instruments in Vintage Keys are complex waves containing many sine waves of various amplitudes and frequencies. A **filter is a device which allows us to remove certain components of a sound depending on its frequency**. For example, a Low Pass Filter, like the one in Vintage Keys, lets the *low frequencies pass* and removes only the high frequencies.

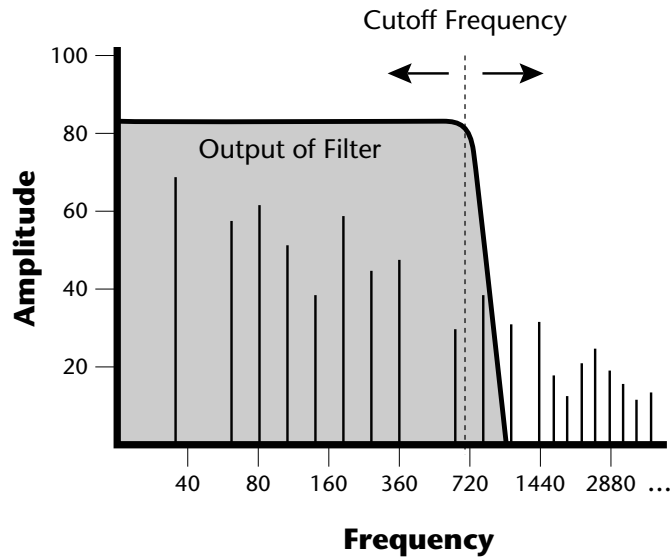

••• When the filter  $F_c$  is 000 all sound will be cut off. The initial filter  $F_c$  and all  $F_c$  modulators ADD algebraically to determine the actual  $F_c$ . If you are not getting sound, adjust the initial  $F_c$  or reduce the amount of modulation. Careful adjustment of all the filter parameters is the secret to getting great sounds.

The point at which the frequencies begin to be cut is called the **Cutoff Frequency** (or  $F_c$  for short). A filter that let only the high frequencies pass would be called a High Pass filter. Using a filter, we now have a way to control the harmonic content of a sampled sound. As it turns out, a low pass filter can simulate the response of many natural sounds.

For example, when a piano string is struck by its hammer, there are initially a lot of high frequencies present. If the same note is played softer, there will be fewer of the high frequencies generated by the string. We can simulate this effect by routing the velocity of the keyboard to control the amount of high frequencies that the low pass filter lets through. The result is expressive, natural control over the sound.

The auxiliary envelope generator is commonly used to control the cutoff frequency of the low pass filter. This allows the frequency content to be varied dynamically over the course of the note. Dynamic filtering coupled with all the different instruments available, makes for almost endless possibilities in the final sound. Any modulation source can be used to modulate the filter.

Another control on the low pass filter is called Q or resonance. Turning up the Q of the filter tends to emphasize the frequencies around the cutoff frequency. The chart below shows how different amounts of Q affect the filter response. In terms of sound, frequencies around the cutoff will tend to “ring” with high Q settings. If the filter is swept back and forth slowly with a high Q, various overtones will be “picked out” of the sound and amplified as the resonant peak sweeps over them. Bells and gongs are real world examples of sounds which have a high Q.

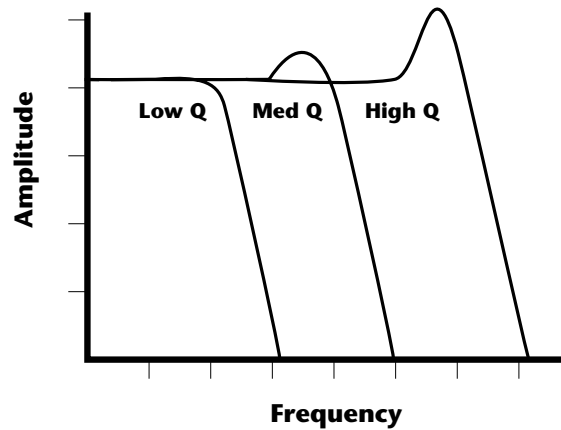

*Turning up the “Q” will emphasize the frequencies around the cutoff point.*

Another parameter on the low pass filter is the number of poles it contains. The filters on Vintage Keys can be either 2-pole or 4-pole filters. The number of poles in a filter describes the steepness of its slope. The more poles the steeper the slope. 2 and 4 pole filters have a very different sound. In general, the 2-pole filter will have a buzzy sound and the 4-pole filter has a stronger filtering action. In terms of vintage synthesizers, Oberheim synthesizers were famous for their 2-pole filter; Moog, ARP and E-mu synthesizers were famous for their distinctive 4-pole filters.

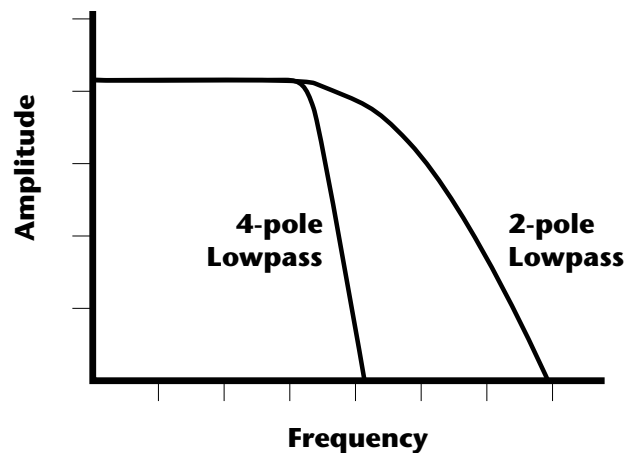

### VINTAGE KEYS SIGNAL FLOW

Going back to the block diagram for a single channel we can re-examine the complete signal path.

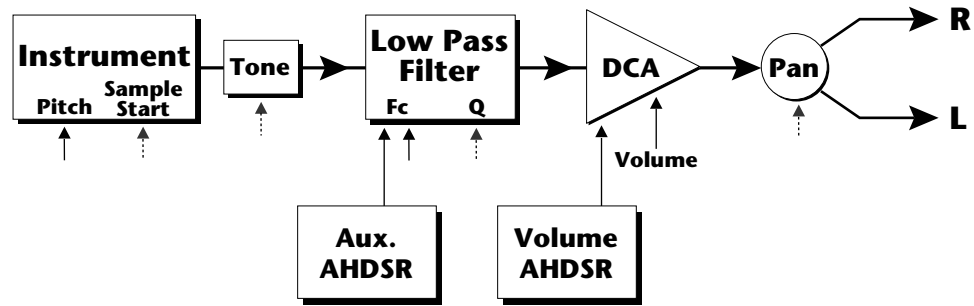

#### *Instrument*

This is the sampled sound wave. The pitch of the instrument can be modulated by any modulation source. The sample start point can only be modulated by a velocity or key source (see the next page).

#### *Tone*

Tone is a simple tone control which can be used to brighten or mute the sound. Tone can only be modulated by a velocity or key source (see the next page). Key velocity is commonly used to modulate the tone so that the harder you play, the brighter the sound becomes.

#### *Low Pass Filter*

The Low Pass Filter is used to shape the harmonic content of an instrument. The Fc can be modulated by any source. The auxiliary envelope is commonly used to dynamically shape the harmonic content over time. Q or resonance can only be modulated by a velocity or key source. There are two types of low pass filter available: a 2-pole filter and a 4-pole filter. The 4-pole filter has a steeper slope and a stronger filtering action.

#### *DCA*

**D**igitally **C**ontrolled **A**mplifier. Together with the Volume AHDSR, the DCA is used to shape the volume contour of a sound. The DCA can be controlled by any modulation source. Key Velocity is often used as a modulation source for the DCA so that the harder you play, the louder the sound becomes.

#### *Pan*

Adjusts the balance of sound to the left and right channels. Pan can only be modulated by a velocity or key source.

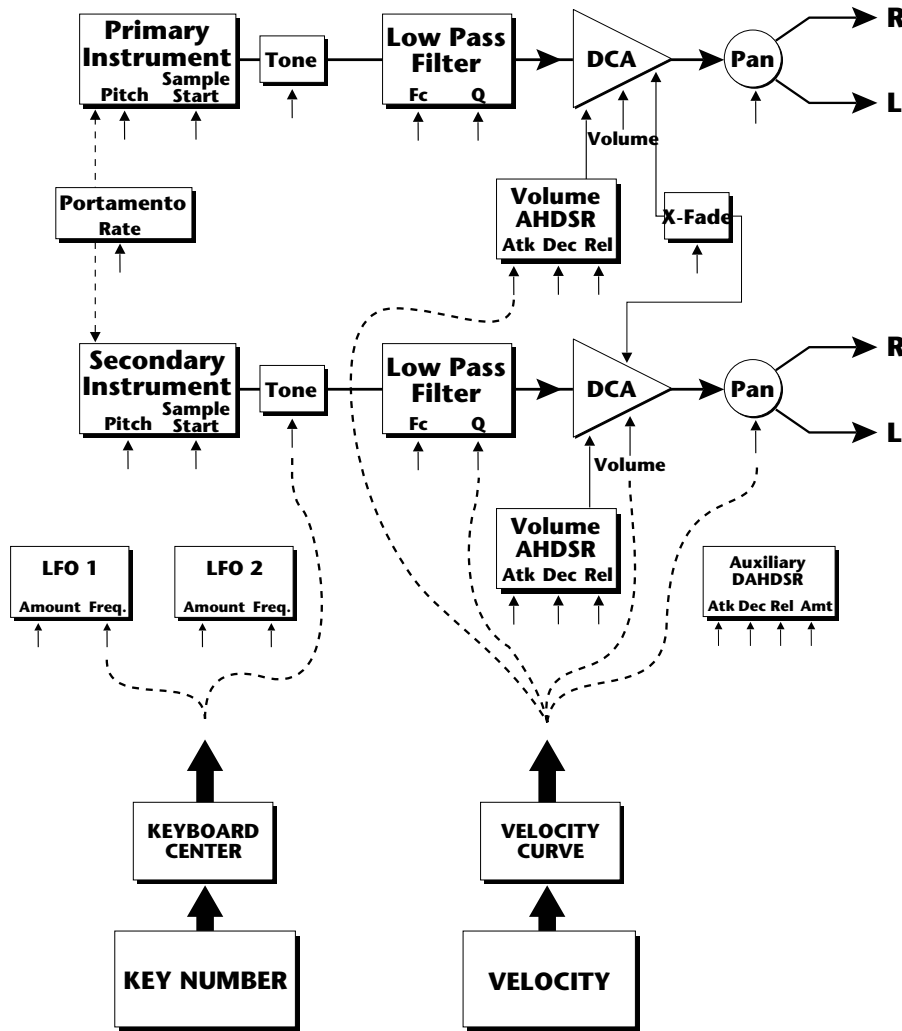

### Keyboard and Velocity Modulation Sources

**Keyboard Modulation Sources**  
 Key Number, Key Velocity

**Destinations**  
 Off, Pitch, Primary Pitch, Secondary Pitch, Filter Fc, Primary Filter Fc, Secondary Filter Fc, Filter Q, Primary Filter Q, Secondary Filter Q, Volume, Primary Volume, Secondary Volume, Attack, Primary Attack, Secondary Attack, Decay, Primary Decay, Secondary Decay, Release, Primary Release, Secondary Release, Crossfade, LFO 1 Amount, LFO 1 Rate, LFO 2 Amount, LFO 2 Rate, Auxiliary Envelope Amount, Auxiliary Envelope Attack, Auxiliary Envelope Decay, Auxiliary Envelope Release, Sample Start, Primary Sample Start, Secondary Sample Start, Pan, Primary Pan, Secondary Pan, Tone, Primary Tone, Secondary Tone, Portamento Rate, Primary Portamento Rate, Secondary Portamento Rate

### KEYBOARD AND VELOCITY MODULATION

The Keyboard and Velocity Modulation diagram shows the possible routing of Key Number (which key is pressed), and Velocity (how hard the key is pressed). These modulation sources can control any of the destinations indicated by the small arrows. A modulation source can control up to six destinations or one destination can be controlled by up to six modulation sources. The possible modulation routings are completely flexible as shown in the example above.

### KEY NUMBER

The Key Number is affected by the Keyboard Center parameter which can be set to any key from A-1 to C7. The keyboard center establishes a reference point for keyboard modulation; keys above this point will have a positive value, while keys below it will be negative. For example, if we wished to change the volume of an instrument using key number and the key center were set to middle C, the instrument would get progressively louder above middle C and progressively softer below middle C.

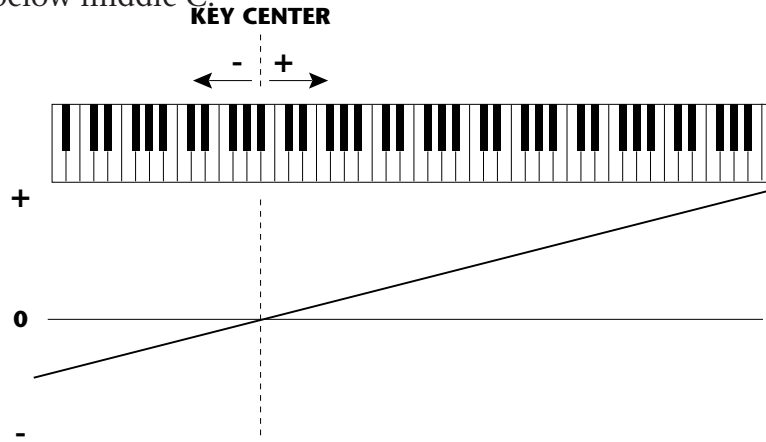

### VELOCITY CURVES

Incoming velocity values can be scaled by one of the four velocity curves in order to match your playing style or better adapt to the MIDI controller. Experiment with the four curves to find the one that works best for your style and MIDI controller.

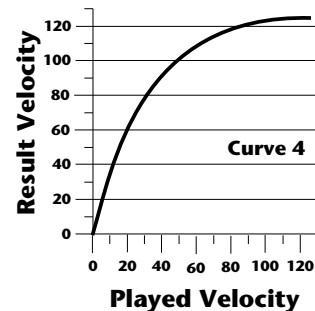
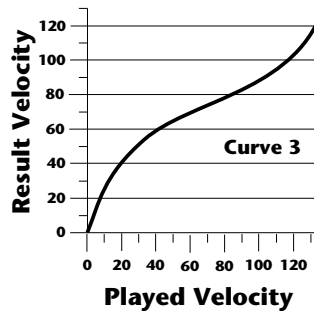
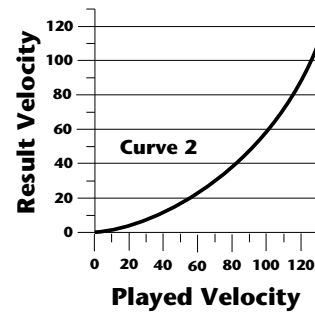
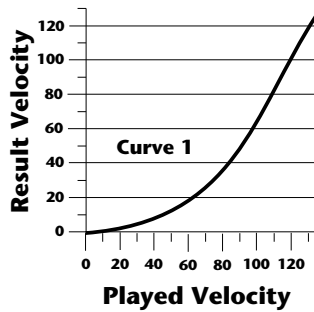

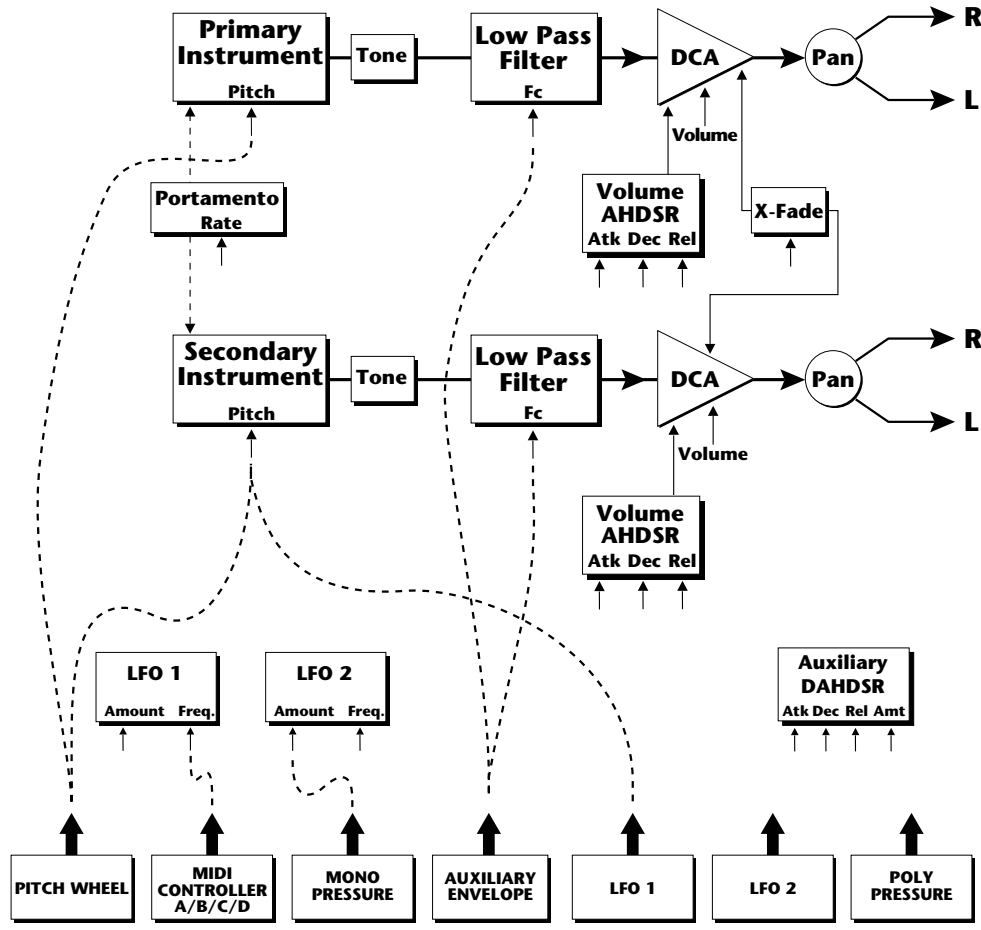

**Realtime Modulation Sources**

**Realtime Modulation Sources**

Pitch Wheel,  
MIDI Control A,  
MIDI Control B,  
MIDI Control C,  
MIDI Control D,  
Mono Pressure,  
Polyphonic Pressure,  
LFO 1, LFO 2,  
Auxiliary Envelope

**Destinations**

Off,  
Pitch, Primary Pitch,  
Secondary Pitch,  
Filter Fc, Primary Filter Fc,  
Secondary Filter Fc,  
Volume, Primary Volume,  
Secondary Volume,  
Attack, Primary Attack,  
Secondary Attack,  
Decay, Primary Decay,  
Secondary Decay,  
Release, Primary Release,  
Secondary Release,  
Crossfade,  
LFO 1 Amount, LFO 1 Rate,  
LFO 2 Amount, LFO 2 Rate,  
Auxiliary Envelope Amount,  
Auxiliary Envelope Attack,  
Auxiliary Envelope Decay,  
Auxiliary Envelope Release,  
Portamento Rate, Primary  
Portamento Rate,  
Secondary Portamento Rate

**REALTIME MODULATION**

In addition to keyboard and velocity modulation, Vintage Keys has multiple realtime modulation sources. Realtime modulation sources are parameters which can be continuously varied over time. The velocity and keyboard modulations, in comparison, are set at the key depression. The realtime modulation sources can control any of the destinations except sample start, Q, tone and pan, as indicated by the small arrows. A modulation source can control up to eight destinations or one destination can be controlled by up to eight modulation sources. The possible modulation routings are completely flexible as shown in the example above.



## MIDI REALTIME CONTROLS

The MIDI realtime controllers may seem confusing at first, but they are really very simple to understand. You probably already know that there are 16 MIDI channels that can be used. Each of the 16 MIDI channels uses basically 3 types of messages; *note on/off*, *program changes*, and *continuous controller* messages. Your MIDI keyboard, in addition to telling Vintage Keys which note was played, may also send *realtime control* information, which simply means occurring in real time or live. (You may be using a MIDI device other than a keyboard, but for simplicity's sake we'll presume that you're using a keyboard.) Realtime control sources include such things as pitch wheels or levers, modulation wheels or levers, control pedals, aftertouch, etc. and are used to add more expression or control. Your MIDI keyboard sends out realtime controller information on separate channels called *continuous controller channels*. There is a set of 32 continuous controller channels for each of the 16 MIDI channels. Some of the controller channels, such as pitch wheel, volume, and pan have been standardized. For example, volume is usually sent on continuous controller channel #7.

••• MIDI wind controllers may work better if you assign one of the MIDI A, B, C, D controllers to control volume. This will allow the MIDI volume to be **added** to the current volume.

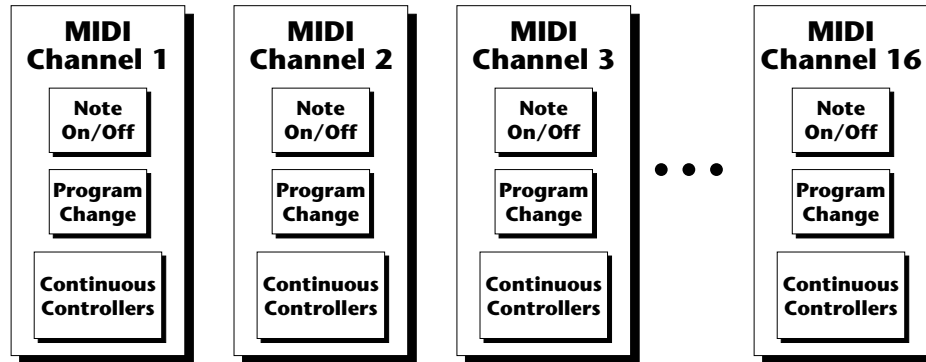

Common realtime controllers such as the pitch wheel, volume, pan and pressure are pre-programmed to their proper destinations. Your keyboard may have other realtime controls such as a control pedal or data slider which can also be programmed to control most of the parameters on Vintage Keys.

Vintage Keys is equipped with a sophisticated *MidiPatch™ system*, which allows you to route any continuous controller to any realtime modulation destination. The MidiPatch system is also very easy to use. First, you must know which controller numbers your keyboard can transmit.

Let's say for example, that you are using a Yamaha DX7 as your master keyboard. The DX has pitch and mod. wheels, a breath controller, a data slider and a foot pedal, all of which transmit their values over MIDI. The standard MIDI controller numbers for the controls are listed below (the pitch wheel has a dedicated controller, PWH). First, we would go to the Master menu, MIDI Controller Assign and define the 4 MIDI controllers that we wish to use. Assign each controller number to one of the letters A-B-C-D.

- 01 - Modulation Wheel      A**
- 02 - Breath Controller      B**
- 04 - Foot Pedal              C**
- 06 - Data Entry              D**

**Standard MIDI Controller Numbers**

- 1 Modulation Wheel
- 2 Breath Controller
- 3 Pressure Rev 1 DX7
- 4 Foot Pedal
- 5 Portamento Time
- 6 Data Entry
- 7 Volume
- 8 Balance
- 9 Undefined
- 10 Pan

To complete the connections for a particular preset, go to the Edit menu, Realtime Control, and route the MIDI A, B, C, D to the desired destinations. These could be patched to any 4 destinations or even to the same destination. The MIDI Controller Amount menu, (in the Edit menu) allows you to scale the amounts of each of the controllers by a positive or negative value. The signal flow is shown in the diagram below.

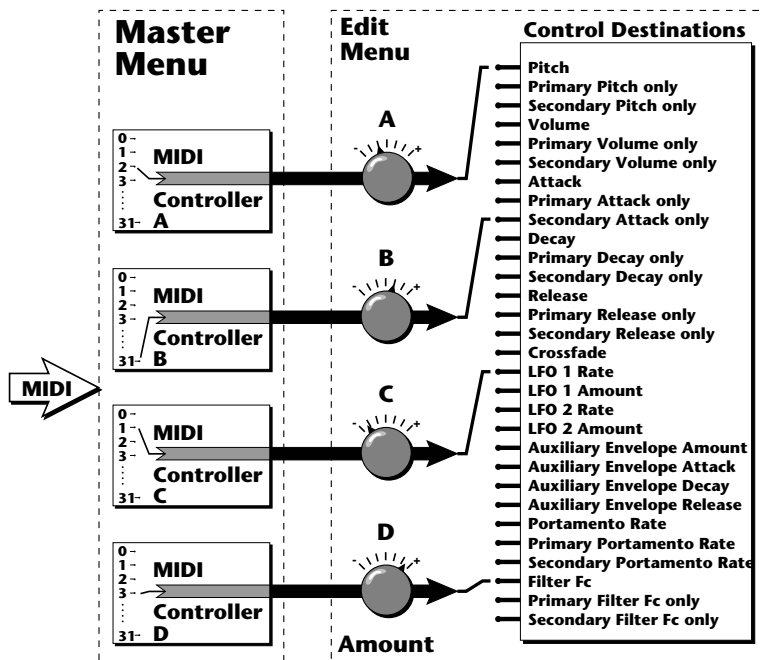

The MIDI controllers A-B-C-D must have both a source (0-31), and a destination assigned.

## STEREO MIX OUTPUTS

Vintage Keys has three sets of polyphonic stereo outputs (Main, Sub 1, Sub 2). The channels used by a particular preset may be directed to appear at any one of these three stereo outputs. This feature is useful for signal processing (EQ, reverb, etc.) of individual sounds prior to final mixdown. By panning a preset completely left or right, it can be routed to a single output jack.

Note: All presets will be automatically routed to the Main outputs unless plugs are inserted into the Sub 1 or Sub 2 outputs.

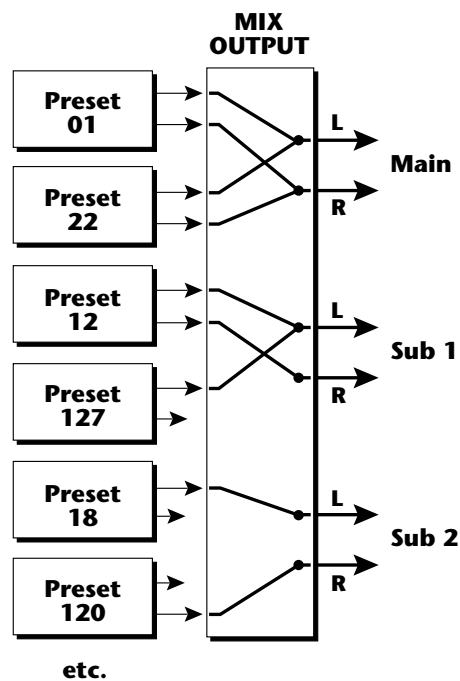

*Each preset can be routed to one (and only one) set of stereo outputs.*



**EDIT  
MENU**



The edit menu contains functions that can be modified by the user and then saved as preset information in one of the user presets. For example, the LFO speed or other parameter can be edited, then the preset can be saved to a user location (0-255).

### **WARNING**

*Changes made in the Edit menu will be forever lost unless the preset is "saved" using the Save Preset function (page 66) before changing the preset.*

#### **To enable the Edit menu**

Press the Edit key, lighting the LED. The current screen will be the one most recently selected since powering up the machine. The cursor will appear underneath the first character of the screen heading on line one.

#### **To select a new screen**

Press the cursor key repeatedly (or hold the cursor key while turning the data entry control) until the cursor is underneath the parameter name. Rotate the data entry control to select the screen.

#### **To modify a parameter**

Press the cursor key repeatedly (or hold the cursor key while turning the data entry control) until the cursor is underneath the parameter value. Rotate the data entry control to change the value.

#### **To return to Preset Select mode**

Press the Edit button, turning off the LED.

••• *While the Edit menu is activated, incoming MIDI preset changes are ignored. This is a quick and easy way to temporarily turn MIDI Preset Change OFF.*

## EDIT MENU FUNCTIONS

- **Preset Name**

Preset Name allows you to name each of the user presets with a name of up to 12 characters. Position the cursor under the character location and use the data entry control to change the character. The keyboard can also be used to select characters. The charts below show the keyboard character assignment.

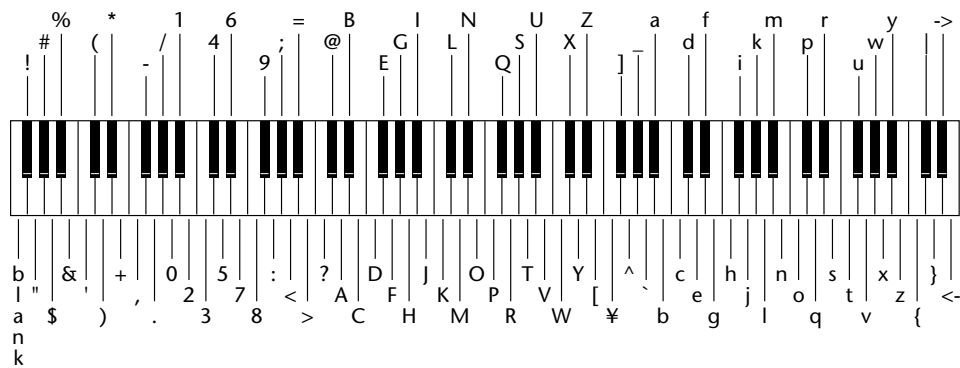
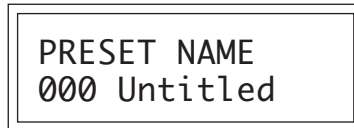

	C	C#	D	D#	E	F	F#	G	G#	A	A#	B	Pitch
-2						blank	!	"	#	\$	%	&	
-1	'	(	)	*	+	,	-	.	/	0	1	2	
0	3	4	5	6	7	8	9	:	;	<	=	>	
1	?	@	A	B	C	D	E	F	G	H	I	J	
2	K	L	M	N	O	P	Q	R	S	T	U	V	
3	W	X	Y	Z	[	¥	]	^	_	`	a	b	
4	c	d	e	f	g	h	i	j	k	l	m	n	
5	o	p	q	r	s	t	u	v	w	x	y	z	
6	{		}	→	←								

**Octave No.**

• **Primary Instrument**

This function allows you to select which of the available instrument sounds (or none) will be placed on the primary layer of the current user preset.



• **Secondary Instrument**

This function allows you to select which of the available instrument sounds (or none) will be placed on the secondary layer of the current user preset.



• **Key Range**

Key range sets the keyboard range of both primary and secondary instruments. This sets the keyboard range for the entire preset and will further limit the primary and secondary keyboard ranges. The key range can be set anywhere from C-2 to G8.

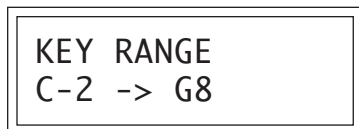

••• Simply changing the instrument creates a new sound while retaining all other parameters of the preset.

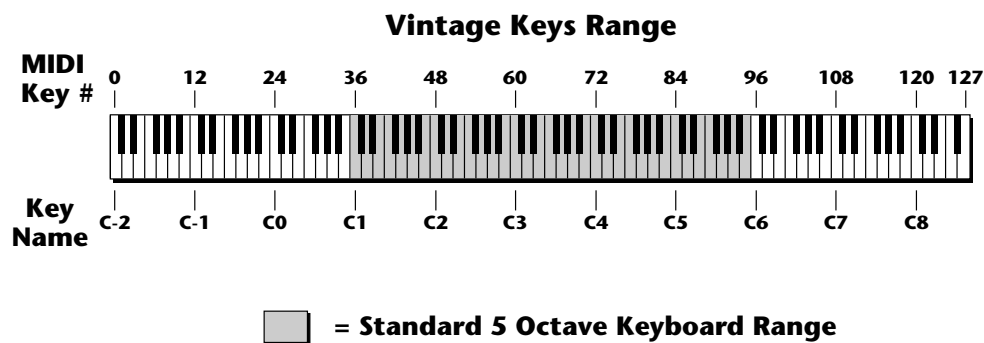



• **Primary Key Range**

Key range sets the keyboard range of the primary instrument. This is useful for creating positional crossfades and keyboard splits between the primary and secondary layers. The key range can be set anywhere from C-2 to G8.

```
KEY RANGE pri
C-2 -> G4
```

• **Secondary Key Range**

Key range sets the keyboard range of the secondary instrument. The key range can be set anywhere from C-2 to G8.

```
KEY RANGE sec
G#4 -> G8
```

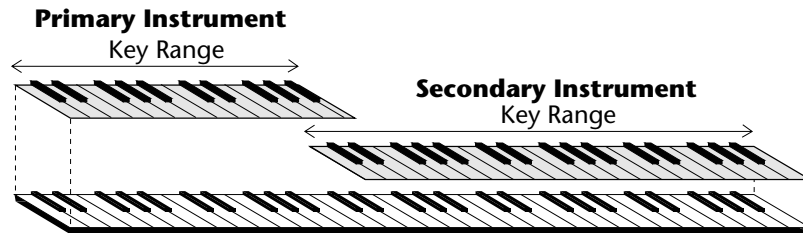

This diagram shows how a “split” keyboard can be programmed using the primary and secondary instruments.

••• Entire presets can also be Linked to form split or layered keyboards.

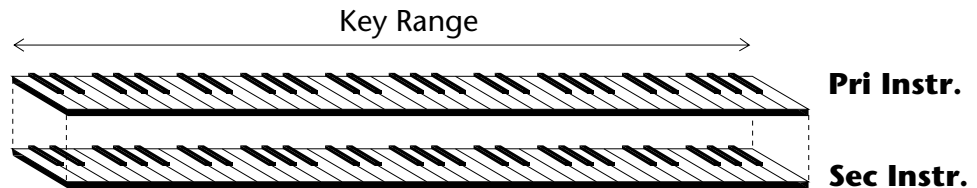

This diagram shows how instruments can be layered or “stacked” using the primary and secondary instruments.

- **Coarse Tuning**

This function allows you to change the tuning of the primary and secondary instruments in semitone intervals. The coarse tuning range is -36 to +36 semitones. A coarse tuning setting of "00" would indicate that the instrument is tuned to concert pitch (A=440 Hz).

```
TUNING coarse
pri:+00  sec:+00
```

- **Fine Tuning**

This function allows you to change the tuning of the primary and secondary instruments in 1/64 semitone intervals (approx. 1.56 cents). The fine tuning range is  $\pm 1$  semitone.

```
TUNING fine
pri:+00  sec:+00
```

- **Volume**

Volume sets the amplitude of the primary and secondary instruments. This function also allows you to compensate for the relative volume differences between instruments.

```
VOLUME
pri:127  sec:64
```

- **Pan**

Pan allows you to independently set the initial pan position of the primary and secondary instruments. A value of -7 pans the instrument hard left and a value of +7 pans the instrument hard right. This pan setting is only valid if "P", for preset pan, is selected in the main display.

```
PAN
pri:-7   sec:+7
```

• **Alternate Envelope On/Off**

Each instrument has its own factory preset AHDSR volume envelope which is normally employed. If a programmable volume envelope is desired, the alternate envelope is used.

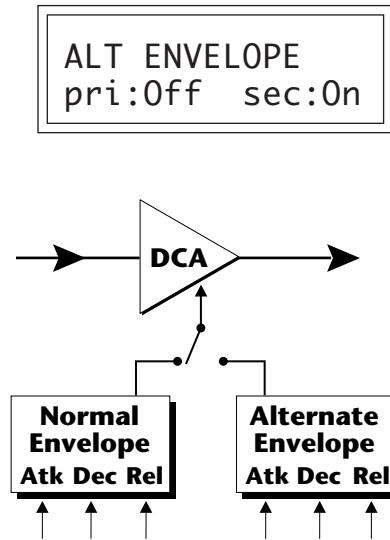

• **Primary Alternate Envelope Parameters**

This function allows you to adjust the alternate volume envelope parameters for the primary instrument. The parameters are Attack time, Hold time, Decay time, Sustain level, Release time and are adjustable from 00 to 99.

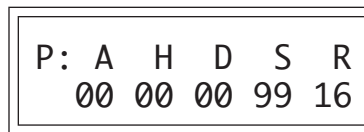

• **Secondary Alternate Envelope Parameters**

This function allows you to adjust the alternate volume envelope parameters for the secondary instrument. The parameters are Attack time, Hold time, Decay time, Sustain level, Release time and are adjustable from 00 to 99.

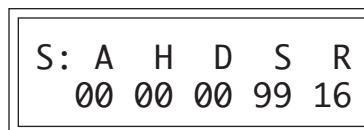

- **Delay**

Delay varies the time between when a MIDI Note On message is received and the onset of a note. The delay time is adjustable from 0 to 13 seconds (000-127).

```

DELAY
pri:000  sec:000

```

- **Sound Start**

This function allows you to set where a sample begins playing when you hit a key. A setting of 000 plays a sound from the beginning, higher values move the sample start point toward the end of the sound.

```

SOUND START
pri:000  sec:000

```

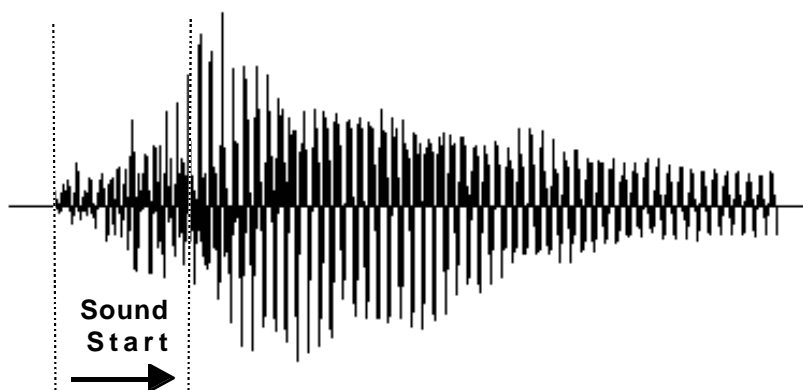

The Sound Start parameter allows you to cut off the beginning of the sound. Higher values move the start point toward the end of the sound.

- **Reverse Sound**

When reverse sound is turned On, the instrument will be played backwards. When an instrument is reversed, any loops in the sound will be ignored, which means that the sound will not sustain indefinitely.

```

REVERSE SOUND
pri:0ff  sec:0n

```

• **Solo Mode**

Solo mode provides the playing action of a monophonic instrument. This mode does not allow you to play a chord. Two types of solo mode are provided: wind controller mode and synth mode. Both modes have single triggering and last-note priority. In either solo mode, if a new note is played while another is being held, the envelope generators will not retrigger. This allows a legato playing technique to be used. Wind controller mode, as its name suggests, provides more realistic effects when working with wind controllers.

**Wind mode**

The envelope generator attack always begins at the start of the attack phase.

**Synth mode**

The envelope generator attack begins at whatever point in the release phase the envelope is in when a new key is pressed.

```
SOLO MODE
pri:Off sec:Wind
```

• **Portamento Rate**

Portamento is a smooth gliding between notes instead of the normal instantaneous change in pitch when a new key is pressed. The portamento rate is the time it takes to glide to the new pitch. The larger the value, the slower the glide rate. The rate is adjustable from 1-127 or it can be turned Off. Portamento glides at a linear rate between notes and can be set separately for the primary and secondary layers. Portamento works both in and out of Solo Mode.

```
PORTAMENTO RATE
pri:127 sec:Off
```

• **Chorus**

Chorus “thickens” the sound by doubling the sound and then detuning it. The chorus amount is variable over a range of 1 to 15. When Chorus is on, the number of channels used by an instrument will be doubled.

```
CHORUS
pri:Off sec:07
```

- **Crossfade Mode**

This function determines which of the following crossfade modes will be selected: Off, Crossfade, or Cross-Switch.

**Off**

When “Off” is selected, none of the crossfade parameters will have any effect.

**Crossfade**

When “Xfade” is selected, a control input is used to fade between the primary and secondary. Any modulation source may be used as an input (velocity, wheel, etc.).

**Cross-switch**

When “Xswitch” is selected, the switched layer is selected if the input crosses a certain threshold or if a footswitch controlling cross-switch is activated. The switch occurs only at the start of the note; no further switching takes place while the key is held down.

If key position or velocity is routed to cross-switch, the threshold is the *switch point*. Realtime controllers do not have any effect when routed to cross-switch. For more information, see Cross-Switch Point on page 55.

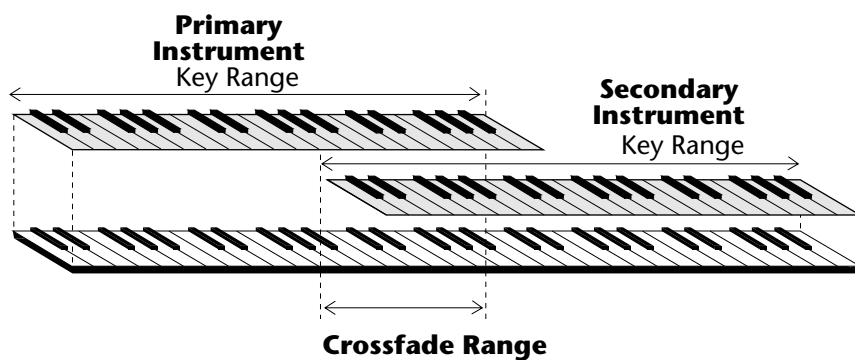

By overlapping the primary and secondary instruments, you can crossfade or cross-switch between the layers.

••• For more information, see *Cross-switch Point* on page 55.

••• To use the keyboard for crossfade, set the *Crossfade Balance* to 64 and the *Key Center* to the split point.

• **Crossfade Direction**

This function determines the polarity of the crossfade or cross-switch. The direction is either primary → secondary, or secondary → primary.



• **Crossfade Balance**

The crossfade balance parameter determines the initial balance between the primary and secondary layers. Higher values shift the balance to the secondary instrument. When the Crossfade Direction is Pri->Sec, Modulation subtracts from the primary volume and adds to the secondary volume. When crossfade modulation and balance equal 64, the two instruments are at equal volume.



••• A Crossfade Balance setting of 000 would be appropriate with a source such as a modulation wheel or footpedal, either of which can only change the value in a positive direction.

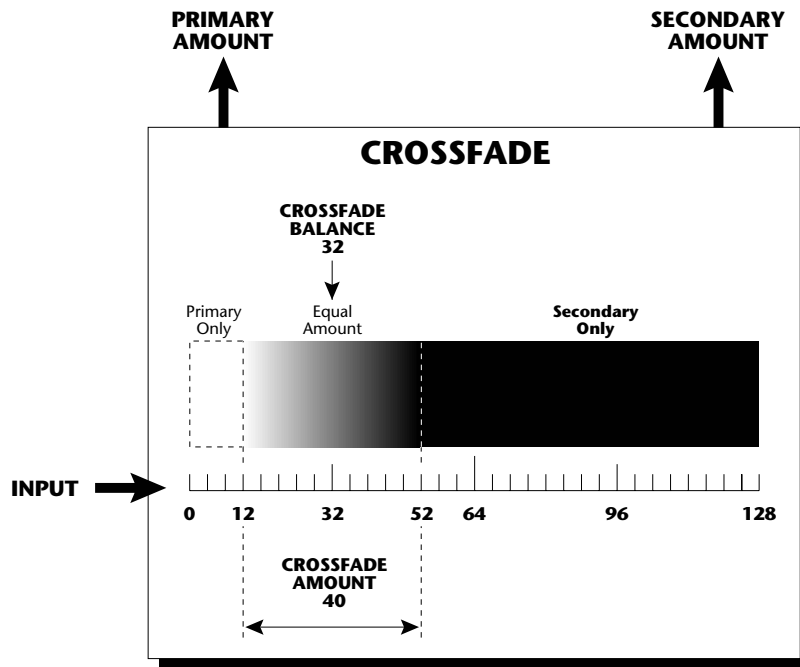

▼ Crossfade must be assigned to a modulation source in the Realtime or Velocity modulation screens.

In the example above, crossfading between Primary and Secondary instruments will occur between the values of 12 and 52. Above and below these points, the output will be completely Primary or Secondary.

• **Crossfade Amount**

The crossfade amount parameter determines the range over which crossfading will occur. Crossfade amount is variable from 000 to 255. The larger the value, the more modulation will be required to effect a complete crossfade.

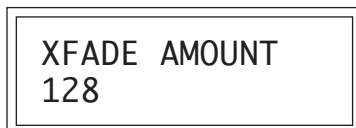

• **Cross-switch Point**

The cross-switch point determines the point at which cross-switching will occur when key position or velocity is controlling cross-switch.



• **Primary Filter Type**

A lowpass filter allows only the low frequencies to pass (lowpass). A lowpass filter can be used to simulate many natural sounds since it is common for the high frequencies to die away as a sound decays. The filter for the primary instrument can be either a 2-pole lowpass filter, a 4-pole lowpass filter, or it can be turned Off. A 2-pole filter attenuates frequencies above the cutoff frequency at 12 dB per octave. A 4-pole filter attenuates frequencies above the cutoff at 24 dB per octave. (A 4-pole filter has a stronger filtering action.)

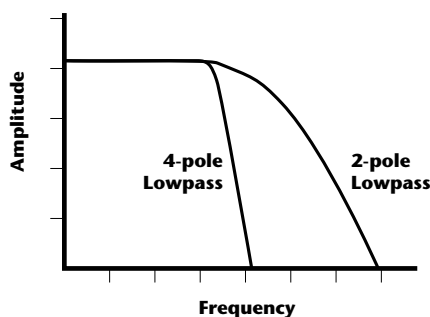
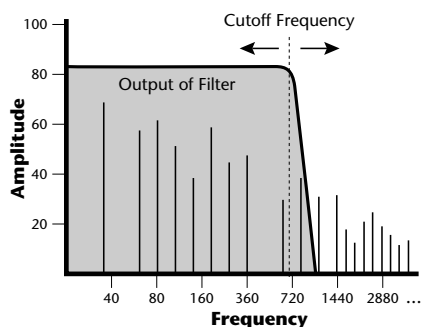

▼ To enable the cross-switch function, you must assign **Crossfade** to a modulation source in the Realtime or Velocity Modulation screen.



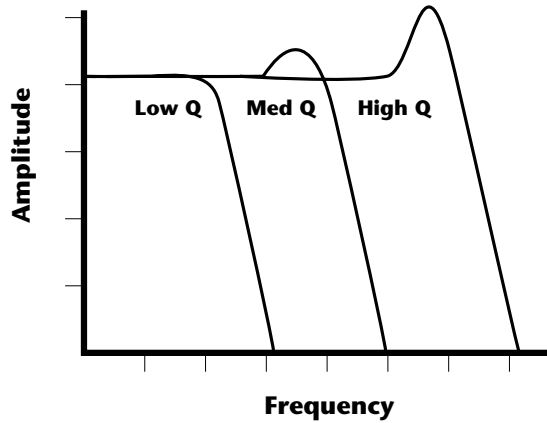

*Q boosts the amplitude at the cutoff frequency. Using high Q values, it is possible to "tune in" certain frequencies of an instrument.*

• **Primary Filter Cutoff & Q**

This function allows you to set the cutoff frequency (the frequency at which filtering begins) and the Q or resonance of the sound. Turning up the Q causes the frequencies near the cutoff to be emphasized.

```

FILTER          pri
Fc:255         Q:5
    
```

• **Secondary Filter Type**

The filter for the secondary instrument can be either a 2-pole lowpass filter, a 4-pole lowpass filter, or it can be turned Off. See Primary Filter Type.

```

FILTER TYPE sec
4 Pole Lowpass
    
```

• **Secondary Filter Cutoff & Q**

This is the same as the Primary Cutoff and Q for the secondary filter.

```

FILTER          sec
Fc:255         Q:5
    
```

• **Auxiliary Envelope**

This is a supplementary, utility envelope that can be routed to any realtime control destination including the lowpass filter. The auxiliary envelope parameters are: Envelope Amount, Delay, Attack Time, Hold Time, Decay Time, Sustain Level, and Release Time. The delay time is variable from 0 to 13 seconds (000-127). The envelope amount is variable from -128 to +127. Negative values will produce inverted envelopes.

```
AUX ENV  AMT DLY
          +127 000
```

```
A:  A  H  D  S  R
    00 00 00 99 20
```

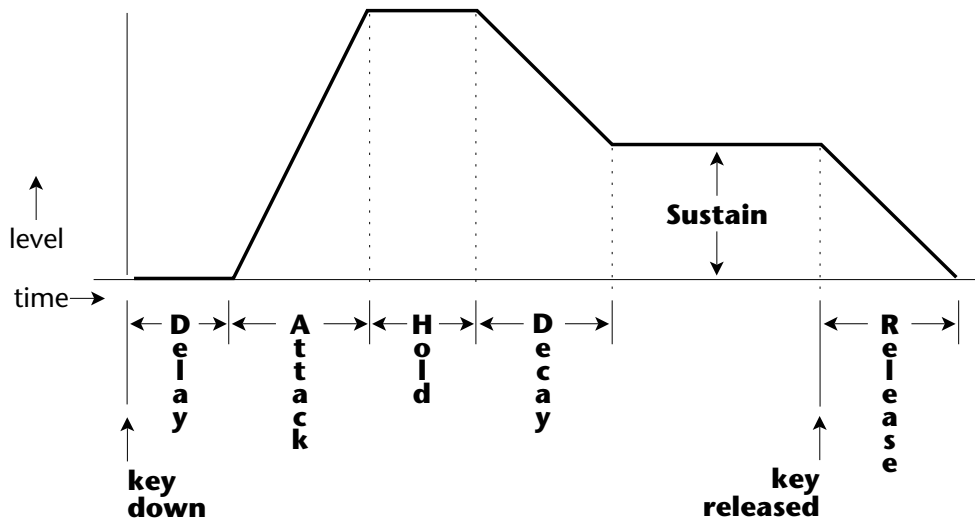

*This diagram shows the six stages of the Auxiliary Envelope Generator.*

• **LFO 1 - Shape & Amount**

This screen controls the waveshape and amount of Low Frequency Oscillator 1. The LFO can be used to produce vibrato (when routed to pitch), or tremolo (when routed to volume). The five LFO waveshapes are: Triangle, Sine, Square, Sawtooth, and Random. The amount can be varied from

-128 to +127. Negative values will produce inverted waveshapes.

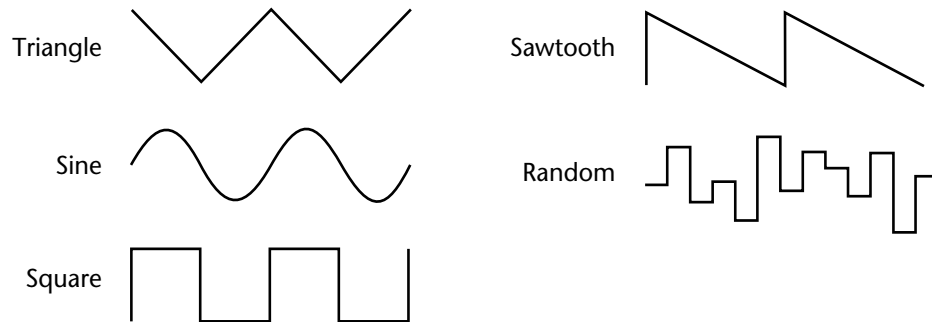

• **LFO 1 - Rate, Delay & Variation**

This screen controls the rate, delay and variation of LFO 1.

**LFO Rate**

Varies the LFO speed from 0.052 Hz to 25 Hz (000-127).

**LFO Delay**

Sets the amount of time between hitting a key and the onset of modulation. This can be used to simulate an effect often used by acoustic instrument players, where the vibrato is brought in only after the initial note pitch has been established. The delay range is variable from 0 to 13 seconds (000-127).

**LFO Variation**

Sets the amount of random variation of an LFO each time a key is pressed. This function is useful for ensemble effects, where each note played has a slightly different modulation rate. The higher the number, the greater the note to note variation in LFO rate. LFO variation is variable from 000-127.

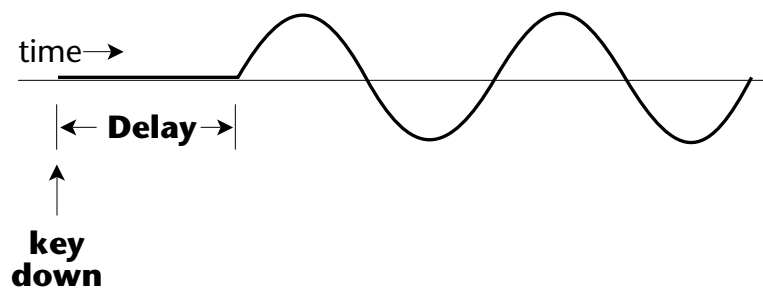

*The LFO wave begins after the specified delay time has elapsed.*

LF01	RT	DLY	VAR
000	000	000	000

- ***LF0 2 - Shape & Amount***

LF0 2 is functionally identical to LF0 1.

- ***LF0 2 - Rate, Delay & Variation***

LF0 2 is functionally identical to LF0 1.

**Keyboard**

**Modulation Sources**

Key Number, Key Velocity

**Destinations**

Off,  
 Pitch, Primary Pitch,  
 Secondary Pitch,  
 Filter Fc, Primary Filter Fc,  
 Secondary Filter Fc,  
 Filter Q, Primary Filter Q,  
 Secondary Filter Q,  
 Volume, Primary Volume,  
 Secondary Volume,  
 Attack, Primary Attack,  
 Secondary Attack,  
 Decay, Primary Decay,  
 Secondary Decay,  
 Release, Primary Release,  
 Secondary Release,  
 Crossfade,  
 LFO 1 Amount, LFO 1 Rate,  
 LFO 2 Amount, LFO 2 Rate,  
 Auxiliary Envelope Amount,  
 Auxiliary Envelope Attack,  
 Auxiliary Envelope Decay,  
 Auxiliary Envelope Release,  
 Sample Start,  
 Primary Sample Start,  
 Secondary Sample Start,  
 Pan, Primary Pan,  
 Secondary Pan,  
 Tone, Primary Tone,  
 Secondary Tone,  
 Portamento Rate,  
 Primary Portamento Rate,  
 Secondary Portamento Rate

**When Modulating Envelope Attack, Decay or Release Times:**

Positive amounts of modulation **increase** the time.

Negative amounts of modulation **decrease** the time.

• **Keyboard & Velocity Modulation Control**

These functions allow you to route keyboard and velocity information to any of the modulation destinations. Up to 6 simultaneous paths or “patches” may be programmed. For each modulation patch, there is a source (keyboard or velocity), and a corresponding amount parameter which is variable from -128 to +127. Place the cursor under the appropriate parameter and change the patch number, modulation source, modulation destination, or the amount using the data entry control. If a parameter is not labeled either primary or secondary, it affects both.

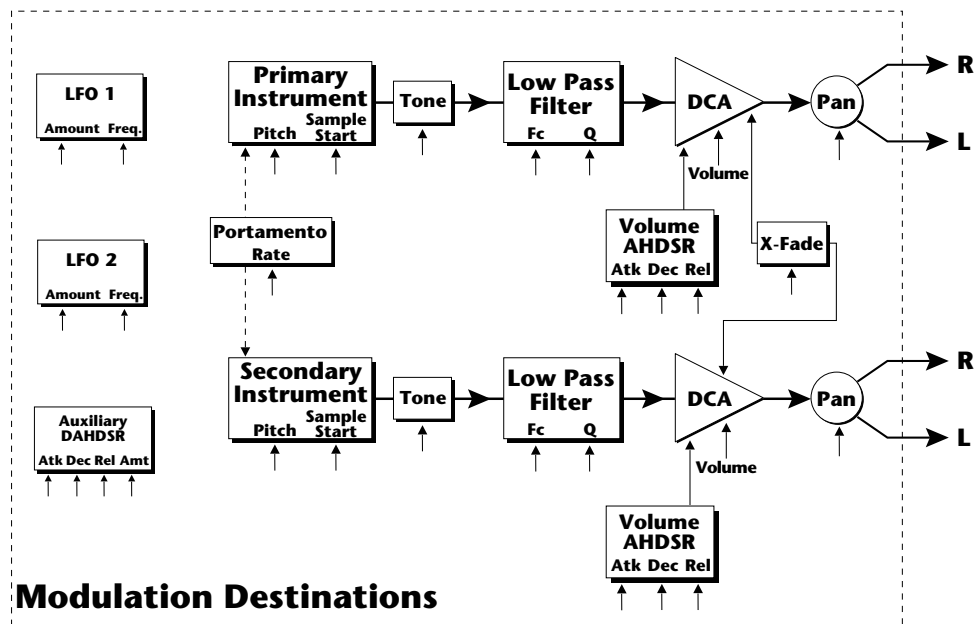
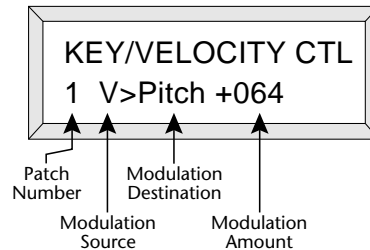

**Modulation Destinations**

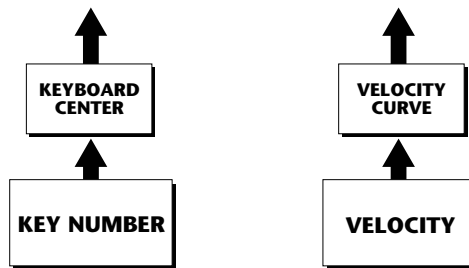

**Keyboard and Velocity Modulation Sources**

• **Realtime Modulation Control**

These functions allow you to route realtime controllers to any of the modulation destinations on except Tone, Sample Start, Q and Pan. Up to 8 simultaneous patches may be programmed. For each modulation patch, there is a source and a destination parameter. **Place the cursor under the appropriate parameter and change the patch number, modulation source or modulation destination using the data entry control.** If a parameter is not labeled either primary or secondary, it affects both.

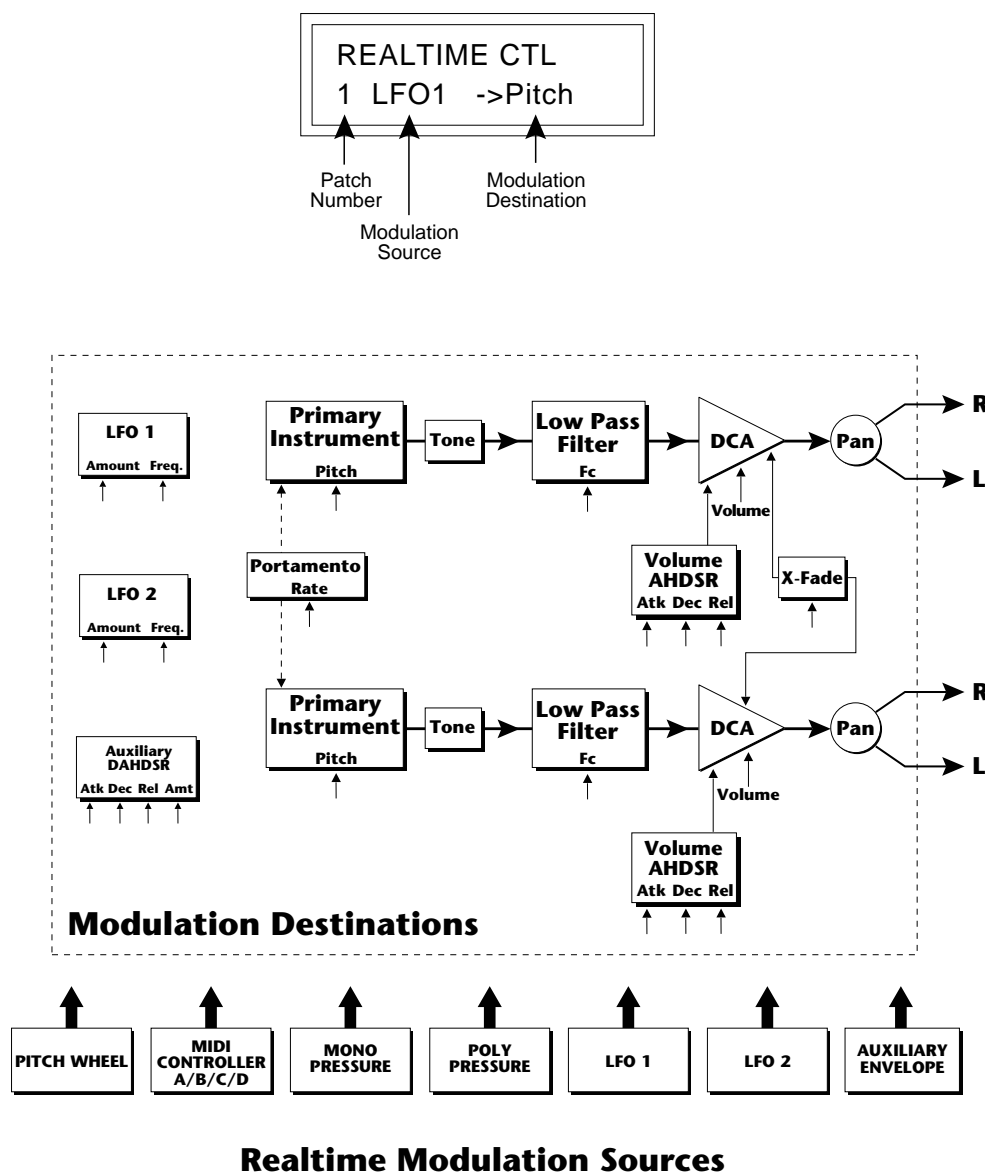

**Realtime Modulation Sources**

Pitch Wheel,  
MIDI Control A,  
MIDI Control B,  
MIDI Control C,  
MIDI Control D,  
Mono Pressure,  
Polyphonic Pressure,  
LFO 1, LFO 2,  
Auxiliary Envelope

**Destinations**

Off,  
Pitch, Primary Pitch,  
Secondary Pitch,  
Filter Fc, Primary Filter Fc,  
Secondary Filter Fc,  
Volume, Primary Volume,  
Secondary Volume,  
Attack, Primary Attack,  
Secondary Attack,  
Decay, Primary Decay,  
Secondary Decay,  
Release, Primary Release,  
Secondary Release,  
Crossfade,  
LFO 1 Amount, LFO 1 Rate,  
LFO 2 Amount, LFO 2 Rate,  
Auxiliary Envelope Amount,  
Auxiliary Envelope Attack,  
Auxiliary Envelope Decay,  
Auxiliary Envelope Release,  
Portamento Rate,  
Primary Portamento Rate,  
Secondary Portamento Rate

• **Footswitch Control**

This function allows you route the 3 footswitch controllers (1, 2 or 3) to any of the footswitch destinations. The footswitches can be routed to switch: Sustain (pri/sec/both), alternate volume envelope (pri/sec/both), alternate volume release (pri/sec/both), or cross-switch between the primary and secondary instruments.

FOOTSWITCH CTL  
1 -> Sustain

• **Pitch Bend Range**

This function allows you to specify the pitch wheel range for the current preset or it can be set to be controlled globally (set in the Master menu). Pitch bend range is only applied when the pitch wheel is used to control pitch.

PITCH BEND RANGE  
+- 12 semitones

• **Pressure Amount**

This function allows you to specify an amount parameter for mono or poly keyboard pressure data. The pressure amount is variable from -128 to +127.

PRESSURE AMOUNT  
+127

• **MIDI Controller Amount**

This function allows you to specify an amount parameter (variable from -128 to +127) for each of the MIDI controllers.

CONTROLLER AMT  
A:+127 B:-090

CONTROLLER AMT  
C:+030 D:+060

• **Velocity Curve**

Incoming velocity data can be modified by a velocity curve in order to provide different types of dynamics in response to your playing or better adapt to the MIDI controller. This function allows you to select one of the four velocity curves or leave the velocity data unaltered (Off). In addition, the velocity curve can be set to “Global”, which means that the global velocity curve (programmed in the Master menu) is used.

VELOCITY CURVE  
Global

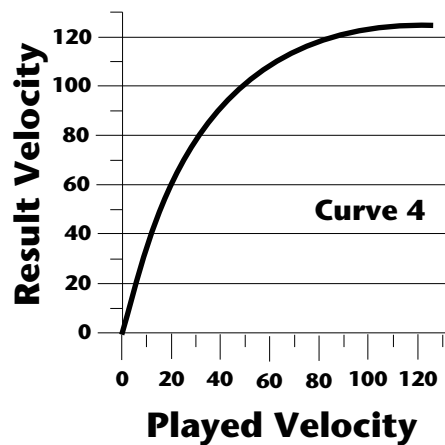
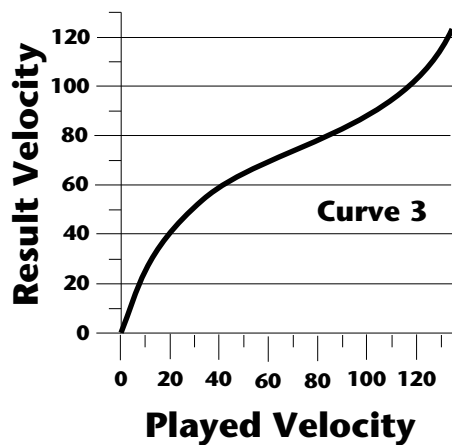
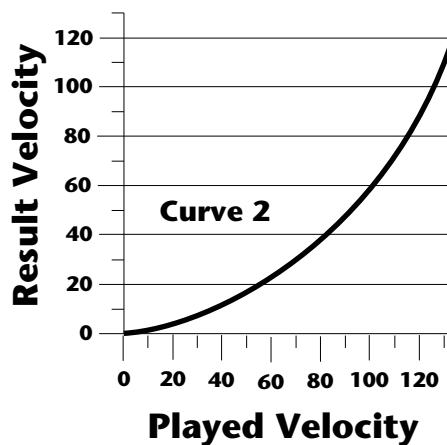
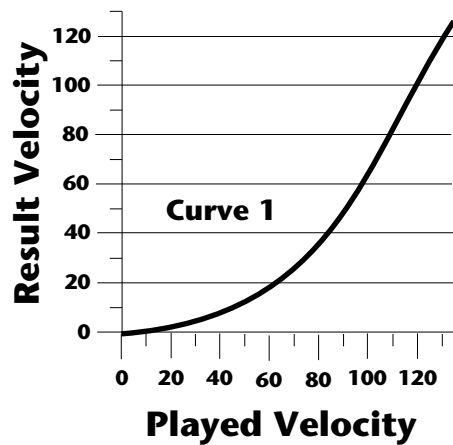



• **Keyboard Center**

The Keyboard Center parameter establishes a reference point for keyboard modulation. Keys above this point will have a positive value and keys below it will be negative. The keyboard center can be set to any key within the range A-1 to C7.

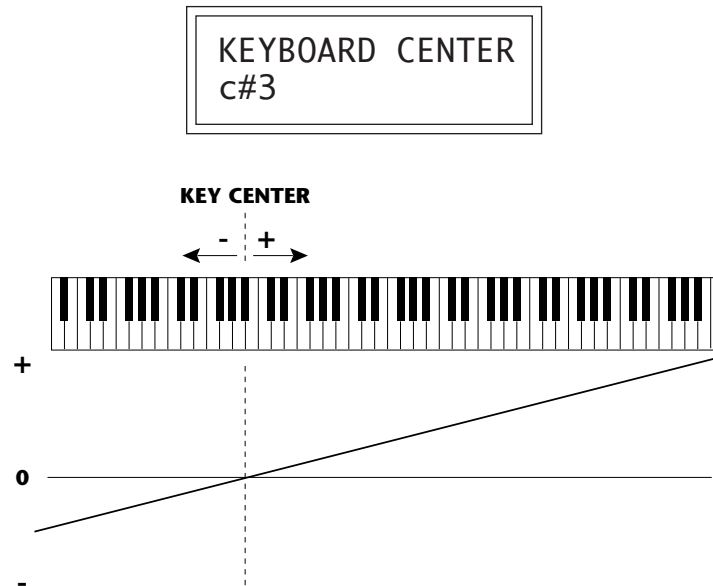

• **Keyboard Tuning**

In addition to the standard equally divided octave tuning, Vintage Keys contains three other types of scale tuning and one user-definable tuning. This function selects which tuning will be used in the current preset. The choices of keyboard tunings are:

**Equal tuning (12 tone equal temperament)**

Standard Western tuning.

**Just C tuning (just intonation)**

Based on small interval ratios. Sweet and pure, non-beating intervals.

**Vallotti tuning (Vallotti & Young non-equal temperament)**

Similar to 12 tone equal temperament. For a given scale, each key has a different character

**19 Tone tuning (19 tone equal temperament)**

19 notes per octave. Difficult to play, but works well with a sequencer.

**Gamelan (Javanese) tuning (5 tone Slendro and 7 tone Pelog)**

Pelog-white keys, Slendro-black keys. Exotic tunings of Gamelan flavor.

**User tuning**

Defined in the Master menu.

• **Mix Output**

This function allows you to direct the channels used by a particular preset to appear at one of these three stereo outputs (Main, Sub 1, Sub 2)

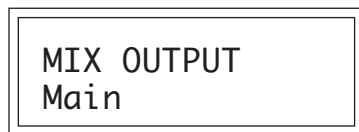

• **Preset Links**

Presets may be linked to other presets in order to create layering or keyboard splits. The current preset can be linked with up to three other presets. Each linked preset can be assigned to a specific range in order to easily create keyboard splits. The modulation parameters specified in each preset remain in effect for each preset in the link.

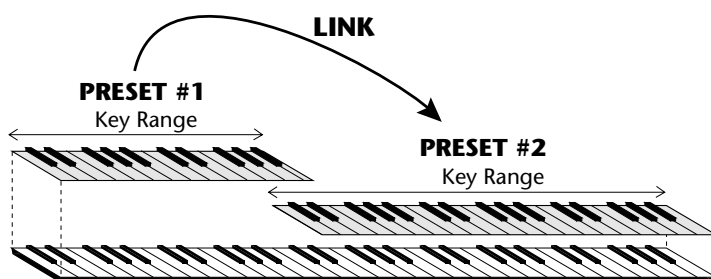
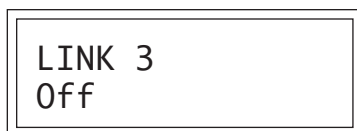
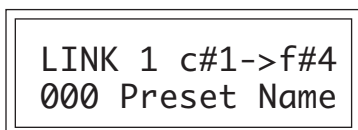

**CREATING A SPLIT KEYBOARD**

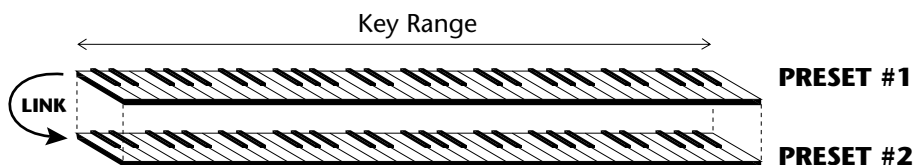

**LAYERING TWO PRESETS**

- ***Save Preset***

Changes made to a preset in the Edit menu are not made permanent until the preset is *Saved*. To save a preset, move the cursor to the bottom line and select the location for the new preset with the data entry control. The Enter LED will be flashing. Pressing the Enter switch will confirm the operation. Any user preset (000-255) may be selected using the data entry control. Writing to a user preset erases the existing preset in that location. Make sure that the destination preset does not contain information that you wanted to keep.

SAVE PRESET to  
064 Preset Name

***To Save a Preset***

1. Select the new location.
2. Press Enter.

---

**PRACTICE  
PROGRAMMING**



This section contains step-by-step instructions on how to get started in programming your own custom sounds. It is recommended that you actually try each example on the Vintage Keys unit, rather than just reading through. The best way to learn something is by actually doing it.

## LINKING PRESETS

Linking presets is a quick and easy way to create new sounds by “layering” presets and also to “split” a keyboard into sections containing different sounds.

### • *Layering Two Presets*

- 1) Select the first preset you wish to layer.
- 2) Press the Edit button.
- 3) Use the data entry control to move through the screens until you find one of the “LINK” screens.
- 4) Move the cursor to the second line of the display, then select the preset that you want to be linked with this preset. You may want to play the keyboard as you scroll through the various presets in order to hear the results.
- 5) If you want the link to be a permanent part of the preset, be sure to “SAVE PRESET”. Otherwise, simply change the preset to erase your work.

### • *Create a Split Keyboard Using Links*

- 1) Follow steps 1 through 4 above.
- 2) Now set the range of the linked preset while still in the LINK menu.
- 3) Save the preset.
- 4) Now go back to the first preset, press the Edit button and use the data entry control to move through the screens to KEY RANGE.
- 5) Set the range of this preset so that it fills the remaining range of your keyboard.
- 6) Save the preset.

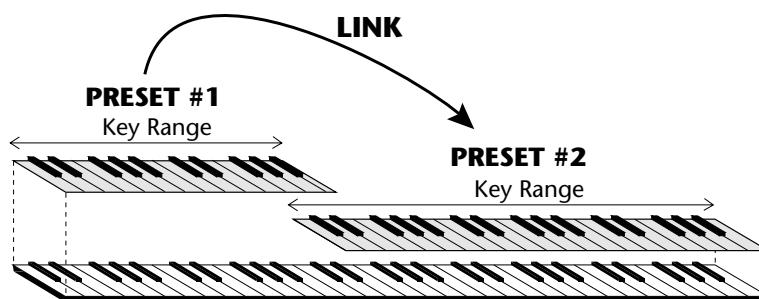

**CREATING A SPLIT KEYBOARD**

••• To get the most out of this section, please read Chapter 3, *Programming Basics* first.

### EDITING PRESETS

The easiest way to make a new preset is to edit an existing preset. This is also an excellent way of becoming familiar with Vintage Keys. If you don't like what you hear, simply change the preset and Vintage Keys reverts back to the original sound. Changes are not made permanent until you **Save** them using the "SAVE PRESET" function, which is the last screen in the Edit menu. Let's experiment and modify a few parameters of an existing preset. We'll start with functions that have an obvious effect on the sound: Instrument Select, Coarse Tuning, Chorus and Reverse Sound.

First, choose a preset that strikes your fancy and press the Edit button.

- ***Changing the Instrument***

This is probably the easiest and most dramatic way to modify an existing preset. Scroll through the Edit menu functions until you come to:

```
INSTRUMENT pri
IXXX Instr Name
```

Move the cursor down to the bottom line (using the cursor button) and change the primary instrument with the data entry control. Play the keyboard as you scroll through the various instruments. When you find an interesting instrument, move the cursor back up to the first line and select:

```
INSTRUMENT sec
IXXX Instr Name
```

Repeat the process for the secondary instrument. Find an instrument that sounds good when combined with the first one you selected. You can probably see that with all these great instruments to work with, you really can't go wrong. Now let's play with the tuning.

### CHANGING THE TUNING OF AN INSTRUMENT

Scroll through the Edit menu functions until you come to:

```
TUNING coarse
pri:+00 sec:+00
```

If the numbers are “00” as in the previous screen, it means that the instruments are tuned to concert pitch (A=440 Hz). Each whole number in coarse tuning represents a semitone interval. To tune one or both of the instruments up an octave, move the cursor to the number (using the cursor button) and set the number to +12 using the data entry control. Try tuning one of the instruments to a perfect fifth above the other. Simply set the coarse tuning to +7.

Tuning an instrument far out of its normal range will completely change the character of the sound. For example, if you tune a bass guitar up 2 octaves, it's going to sound rather petite. On the other hand, if you tune it down 2 octaves, you can probably rattle plaster off the walls! Experiment with radical pitch shifting. You'll be surprised at the results.

## CHORUS

This is an easy one. With the cursor on the top line of the display, turn the data control until you find CHORUS. Various amounts of chorusing can be selected for each of the primary and secondary instruments. Chorus works by doubling the instruments and detuning them slightly. The larger the number, the more detuning will occur. *Warning: Since it works by doubling the instruments, chorus halves the number of notes you can play on Vintage Keys.* Chorus is useful when you want to “fatten up” a part quickly and easily. Just turn chorus on! (The single cycle waves love chorus.)

```
CHORUS
pri:07  sec:0ff
```

## REVERSING THE INSTRUMENT

A simple concept. The instrument sounds can be played in reverse. This will normally make an instrument sound quite a bit different. It also virtually doubles the number of raw instruments you have to work with, and it's fun.

```
REVERSE SOUND
pri:0ff  sec:0ff
```



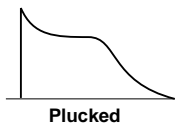
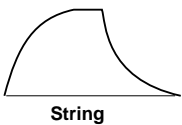
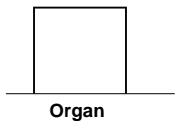
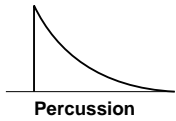

••• The generalized volume envelope shapes of a few types of sounds are shown above.

## ALTERNATE VOLUME ENVELOPE

Every sound you hear, be it a piano note, a drum, a bell or whatever, has a characteristic volume curve or envelope, which grows louder or softer in various ways during the course of the sound. The volume envelope of a sound is one of the clues that our brain uses to determine what type of sound is being produced.

Every instrument in Vintage Keys has its own volume envelope which is used when the Alternate Envelope parameter is turned Off. By turning the Alternate Envelope On, we can re-shape the instrument's natural volume envelope any way we want. By reshaping the volume envelope of an instrument, you can dramatically change the way the sound is perceived. For example, by adjusting the envelope parameters, you can make "bowed" pianos or backwards gongs. The diagrams at the left show the volume envelopes of a few common sounds.

In preparation for this experiment choose a fairly "normal" preset (like an organ or piano) which continues to sustain when the key is held down. Go to the Secondary Instrument screen and set it to "None".

Next go to the Alt. Volume Envelope screen and turn the Primary Volume Envelope On.

```
ALT VOL ENVELOPE
pri:On  sec:Off
```

Now move on to the next screen:

```
P: A H D S R
   00 00 10 99 10
```

Increase the Attack time and play a note. The attack controls the time it takes for the sound to reach full volume when a key is pressed and held.

Now increase the Release time and note the effect as you release the note. The Release time controls the time it takes for the sound to die away when a note is released.

### • Anatomy of an Envelope

When a key is pressed, the envelope generator starts increasing at the **Attack** rate. When it reaches full level, it **Holds** at that level for the **Hold** time. After the Hold time has elapsed, the envelope begins to **Decay** back down at the specified Decay rate until it reaches the **Sustain** Level. Note that all the other parameters are *Times*, but the Sustain is a *Level*.

The envelope will stay at the Sustain level for as long as the key is held. When the key is released, the envelope falls back down to zero at the **Release** rate.

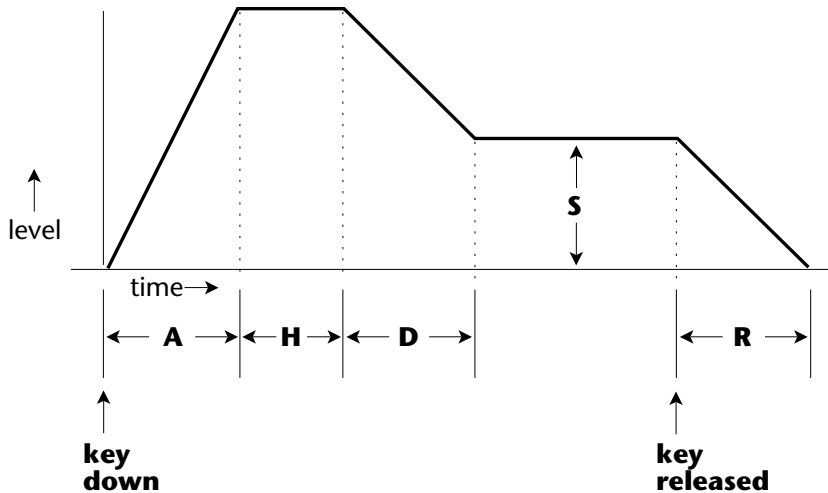

### WORKING WITH THE FILTER

The low pass filter makes it possible to remove certain components of the sound. A low pass filter removes the high frequency components or put another way, it “lets the lows pass”. In preparation for this experiment choose a fairly “normal” preset (like an organ or piano). Go to the Secondary Instrument screen and set it to “None”, then set the Primary Instrument to one which is rich in harmonics, such as the Violin Trio. (Since the filter works by removing certain frequencies, we want to make sure that we have a lot of frequencies to start with.). Set the parameters as listed in the chart below in order to “clean the slate” for your filter investigation.

Go to the primary filter cutoff and Q screen shown below and position the cursor below the Fc value.



Primary	
<b>Instrument:</b>	Violin Trio
<b>Tuning course:</b>	+00
<b>Volume:</b>	100
<b>Alt. Vol. Envelope:</b>	Off
<b>Realtime CTL:</b>	1-8 -> All Off
<b>Filter Type Pri:</b>	4 Pole Lowpass
<b>Filter Fc:</b>	255
<b>Filter Q:</b>	00
<b>Aux Envelope Amt:</b>	+000
<b>Aux Env.:</b>	A: A H D S R 40 00 00 99 50

Playing the keyboard now, you should hear the raw Violin Trio sound. Slowly decrease the filter Fc as you play the keyboard. The sound will get duller and duller as more and more high frequencies are filtered out until at some point the sound will completely disappear. (You have filtered out everything.) The chart below illustrates what you just did. You moved the cutoff frequency down.

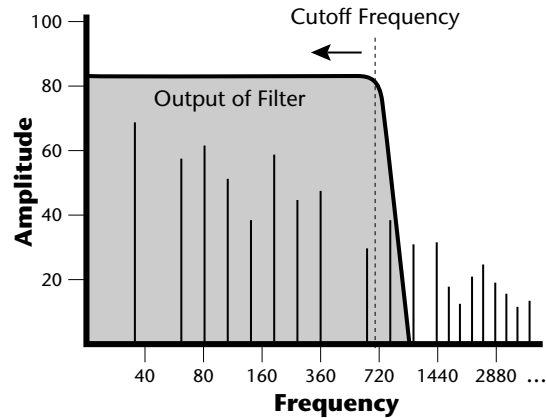

Open the filter back up to 255, then move the cursor underneath the Q. Set the Q to 15, then move the cursor back under the Fc. As you change the Fc, notice that the sound now has a sharp, nasal quality. With a high Q, frequencies at the cutoff frequency (Fc) are being boosted or amplified.

Now let's modulate the filter Fc with the Auxiliary envelope generator. The envelope generator is a device that can automatically change the filter Fc during the course of the note. Set the Fc way down until you can just hear the sound (about 60), then press Enter and go to the REALTIME CTL screen.

```

REALTIME CTL
1 PWhl -> Off
    
```

Move the cursor down underneath the source and set it to Aux (for Auxiliary Envelope). Next move the cursor underneath the destination and set it to Filter Fc. The screen should look like this:

```

REALTIME CTL
1 Aux -> FiltFc
    
```

You have just connected the Auxiliary Envelope Generator to the Filter Cutoff as shown in the diagram below.

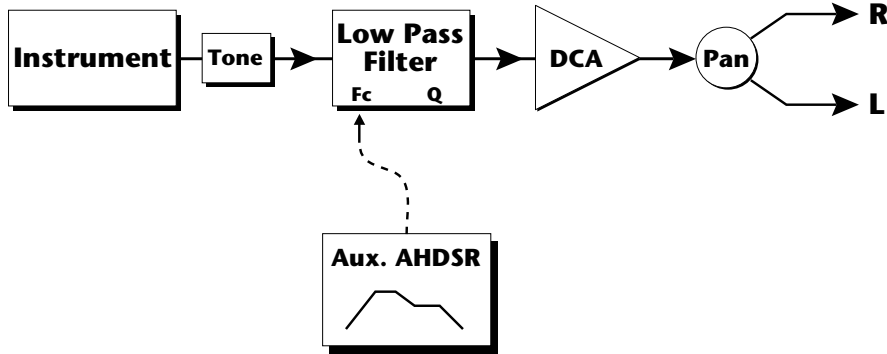

Now go back to the Aux Envelope screen shown below.

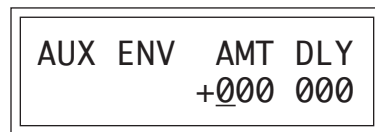

Move the cursor underneath the envelope amount and change the value to about +100. Now when you press a key the filter will slowly sweep up. Because the filter Q is set high, you can hear the different harmonics of the sound being accentuated as the filter cutoff sweeps past.

Now, scroll back to the Auxiliary Envelope parameter screen.

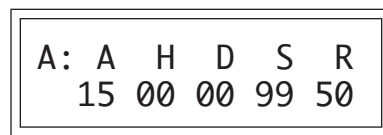

Change the attack rate and note the change in the sound. The diagram below shows approximately how the envelope looks when the parameters are set as shown above.

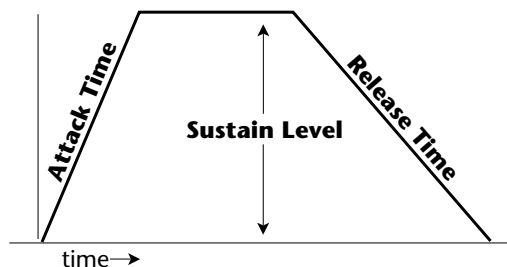

••• Note that all the envelope parameters are **Rates** except for **Sustain**, which is a **Level**.

Because the Sustain level is set to maximum, the decay parameter has no effect. Lower the Sustain to 00, then set the Decay to around 27.

```

A: A H D S R
   15 00 27 00 50
    
```

Now the filter sweeps up, then decays back down to the Sustain Level (which is zero). Play with the envelope parameters for awhile to get a feel for their function. (If you're having trouble understanding the Envelope Generators, please refer to the Programming Basics section in this manual.)

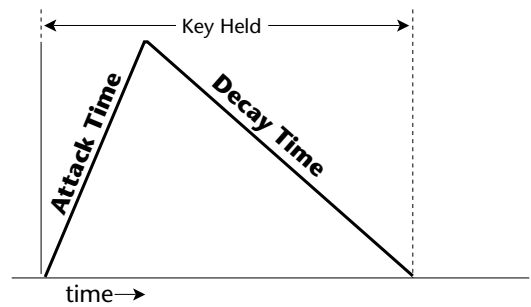

• **Troubleshooting**

A common source of confusion when working with the filter envelope is that the Attack or Release parameter might not seem to be working correctly. Referring to the diagram below which shows the Vintage Keys signal flow, you will notice that the DCA comes *after* the Filter. The DCA controls the final volume of the sound, so if the filter's release is longer than the release for the DCA, you won't hear it, because the DCA has already shut off the sound.

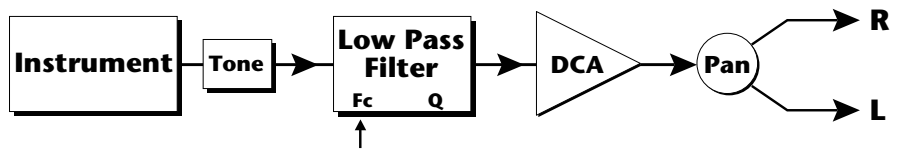

This is just an example of why troubleshooting is important. If you are not getting the expected result, try to analyze the situation. There will be many times when you will have to stop for a minute and think, "What am I trying to do and why isn't it working?" When this happens (*and it will*), don't panic. Troubleshooting is a normal part of the synthesis process. Simply examine the various parameters and try to be as analytical as possible as you solve the problem. Usually the solution will be simple. (The filter is already wide open and can't open any more.) Learning to play an instrument takes... Practice.

You're probably getting the general idea by now. Remember not to change presets or the preset will return to normal. If you want to save your creation, select the last screen in the Edit menu and select a destination preset location for your masterpiece, then press Enter.

### Practice Modulating

- Try modulating the pitch with the Aux. Envelope generator
- Use velocity to modulate the Aux Envelope Amount or the filter Fc. (Key/Vel. screen). This will brighten the sound as you play harder.
- Program the LFO to modulate filter Fc and volume (Realtime modulation screen).
- Modulate the LFO with the other LFO, with velocity, and with the modulation wheel.
- Think of ten different modulation routings, then try them out. The key to learning about Vintage Keys is to experiment.

••• Presets can be stored in any of the non-volatile RAM locations (0-255).

## VINTAGE SYNTHESIS

Vintage Synthesis is actually just a form of additive synthesis. Only, instead of building a sound from simple sine waves, Vintage Keys supplies you with complete sampled sounds or complex waveforms allows you to combine all or part of these together to form a new sound. The process is illustrated below.

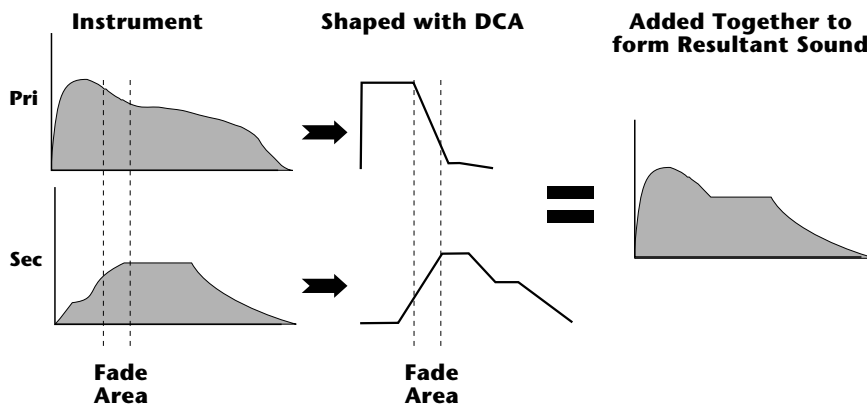

Portions of two sounds are dynamically crossfaded in order to produce a new sound containing elements of both.

The envelope generators controlling the DCAs (digitally controlled amplifiers) can be used to fade between two instruments (primary and secondary) during the course of a note. This powerful technique allows you to combine elements of different instruments together to form completely new sounds.

For example, the attack portion of one instrument can be crossfaded into the body of another instrument, creating a hybrid of the two. Vintage Keys also contains many digitally generated waveforms that may be combined with other digital waves or with sampled instruments in order to change the character of the sound, perhaps to add a digital “edge” or add bass. In addition to the envelope generators, parameters such as Delay, Sound Start and Crossfade allow you to further control the blend of primary and secondary instruments. And of course, the dynamic Low Pass Filters allow you to control the harmonic content of each instrument during the course of the note.

### • *Creating a New Sound*

As an example, let's add a sampled flute attack to a Mini Moog synthesizer sound to create a sort of Flute Synth. Start with one of the default presets and change only the parameters listed in the chart below. The flute instrument is shaped by the Alternate Volume Envelope so that only the breathy attack “chiff” is heard (*a short Decay with the Sustain set to zero*). Also the attack time has been set to 2 to soften the breath sound a bit.

The Mini Moog 1 instrument serves as the body of the sound. The delay parameter is used to delay the onset of the Mini Moog until the flute sound has died away. The Attack parameter of the Secondary Alternate Volume Envelope is set so that the Mini Moog will smoothly fade in as the Flute is fading out. Lastly, the volume of each instrument is adjusted to balance the sound.

Primary	Secondary
Instrument: Flute	Instrument: Mini Moog 1
Volume: 127	Volume: 91
Alt Envelope: On	Alt Envelope: On
A H D S R	A H D S R
02 02 16 00 16	12 00 43 59 40
Delay: 000	Delay: 003

## REVERB SPACES

The reverb spaces allow you to add reverb ambience to Vintage Keys drums. By layering an instrument containing only reverb with a “dry” drum instrument, the effect of real reverb is created. In addition, the reverb spaces can be shaped and filtered just like any other instrument. There are eleven reverb spaces (instruments 76-84, 86, 88) in Vintage Keys.

Using the reverb spaces is easy. Use one of the default presets as your starting point. Set up the Edit menu parameters as in the chart on the following page and change only the parameters specified.

••• *The reverb spaces were created on our Emax II 16-bit sampling system using a technique called Transform Multiplication.*

Primary	Secondary
Instrument: Drum Kit 1	Instrument: Medium Room
Alt Envelope: Off	Alt Envelope: Off
Volume: 100	Volume: 127

All we have done here is layer a drum kit with a reverb space, then adjust the volumes slightly. That's all there is to it! Try out all the different reverb spaces and note the differences. The reverb decay time can be shaped using the Alternate Volume Envelope.

The reverb spaces can be further shaped using Reverse, Chorus, the Low Pass Filter or any of the other modulation parameters. How about using the Auxiliary Envelope to control the pitch of the reverb? You can do all kinds of new things with this reverb.

## USING VINTAGE KEYS WITH A SEQUENCER

We thought you'd never ask. Vintage Keys was designed from its conception with multi-timbral sequencing in mind. Just take a look at the main screen.

```
C01 Vol127 Pan=P
000 Preset Name
```

The preset for each MIDI channel is selected from the main screen. Press the cursor button to move the cursor up so that it is underneath the channel number.

```
C01 Vol127 Pan=P
000 Preset Name
```

Turn the data entry control and you will see that every MIDI channel has a preset assigned to it. Just select a preset for each of the MIDI channels. It's simple! In order to respond to multiple MIDI channels, Vintage Keys must be in Multi-Mode. Multi-Mode is selected in the Master menu. Press the Master menu button and use the data entry control to scroll through the screens until you find MIDI MODE.

```
MIDI MODE    ID
Multi        00
```



Move the cursor down to the second line and change the mode to **Multi** as shown. Vintage Keys will now respond to multiple MIDI channels.

### MORE ADVANCED SEQUENCING

#### • *Pre-Sequence Setup*

Suppose that you want to have your sequencer set up everything for you before the start of the song. Good idea. This will make the Vintage Keys setup procedure automatic and prevent the wrong presets from playing.

The basic idea of a pre-sequence setup is to send out MIDI information just before the start of the song. This MIDI information will select all the proper presets, adjust the mix, and pan positions of each preset.

**Note:** Vintage Keys setup information should be transmitted from the sequencer *before* the song actually starts, perhaps during a lead-in measure or countdown. DO NOT send setup information just before the first beat of the song or MIDI timing errors could result.

#### • *Initial Setup*

In the Master menu:

- 1) Turn ON Multi-Mode
- 2) Turn ON Preset Change enable for each channel.
- 3) Turn OFF MIDI Enable on MIDI channels that are to be used for other synthesizers.

#### • *Preset, Volume & Pan Setup*

Program your MIDI sequencer to transmit the following information before the song starts.

- 1) Select the proper presets for each MIDI channel used on Vintage Keys.
- 2) Send MIDI volume information (controller #7) for each MIDI channel used on Vintage Keys.
- 3) Send MIDI pan information (controller #10) for each MIDI channel used on Vintage Keys.

Now your song will play perfectly every time using the proper presets, volumes and pan positions. In addition, presets, volumes and pan positions (or anything else for that matter) can be adjusted in realtime during the song. Note: If the wrong presets are being selected, check the MIDI Program -> Preset map.

To carry the pre-sequence setup even further, you can even include preset data for each preset used in the sequence. See page 22 for details.

••• *The Preset, Volume and Pan information for all 16 channels is included when the Master Settings are transmitted or received over MIDI.*

••• *The MIDI specification only allows for changing presets 0-127. If you need to access presets in locations above 127, use the Program → Preset Map (page 21). You can save the Program → Preset Map along with your sequence by saving the Master Settings (page 22).*

### • *Using the 32 Channels*

As stated earlier, Vintage Keys has 32 independent audio channels which are utilized dynamically. With 32 channels and 383 presets, you have a universe of sonic textures at your disposal. You may have noticed that many of the very big sounding presets in Vintage Keys are *linked* with other presets or they have *chorus* applied to them. While this is fine when the preset is played solo, you may begin to run out of channels when Vintage Keys is played multi-timbrally. Linking and chorusing cause twice as many channels to be used by the preset. Learn to “budget” your output channels for maximum efficiency.

### • *Channel Ripoff*

When Vintage Keys uses up all its 32 channels and needs more, it steals a channel from the key that has been held the longest. This is commonly known as “channel rip-off”. You will most commonly encounter this “rip-off” when using Vintage Keys in multi-timbral mode or when using massive preset links. Since Vintage Keys dynamically allocates channels as needed, to eliminate rip-off you must either, play fewer notes, use simpler sounds, turn off doubling (pri/sec, chorus, or linked presets), or use MIDI overflow to another Vintage Keys unit.

### • *Using External Processing*

Don't be afraid to use external processing on specific sounds if you feel the urge. The submix sends and returns on Vintage Keys are there for a reason. In many instances a bit of reverb or EQ will be just the thing an instrument needs to give it a distinct identity. Incidentally, an external fuzz box can work wonders on the clean guitar sound. If you think about it, adding distortion to a clean guitar sound is much closer to the way an electric guitar is normally processed. By dedicating one of your old fuzz boxes to a submix out/in, you can have programmable distortion for use on guitars, organs or whatever.

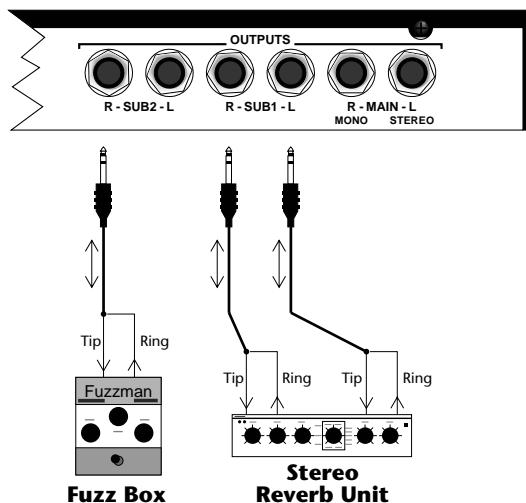

*Using the programmable outputs and returns, specific presets can be routed through your favorite effects without using up precious mixer channels.*



---

**REFERENCE  
SECTION**

## FACTORY PRESETS - RAM

### Vintage Keys Presets

0-255 RAM

256-511 ROM

0. Hmnd B3 01	43. Clav 06	86. Pad: Fairlight
1. Fndr Rds 01	44. Clav 07	87. Pad: OB Port
2. Wurli 01	45. Clav 08	88. Pad: P5 Piper
3. Clav 01	46. Clav 09	89. Lead: Moog01
4. TronStrng 01	47. Clav 10	90. Lead: Moog02
5. CP Grand 01	48. Clav 11	91. Lead: Moog03
6. Bass: Moog 01	49. TronStrng 02	92. Lead: Arp 01
7. Pad: Moog 55	50. TronStrng 03	93. Lead: Arp 02
8. Lead: P5 Sync	51. TronFlute 01	94. Lead: Arp 03
9. Hmnd B3 02	52. TronFlute 02	95. Lead: SEM 01
10. Hmnd B3 03	53. TronFlute 03	96. Lead: SEM 02
11. Hmnd B3 04	54. TronChoir 01	97. Lead: EMU Tri
12. Hmnd B3 05	55. TronChoir 02	98. Lead: EMUSaws
13. Hmnd B3 06	56. TronChoir 03	99. Lead: EMUSqrs
14. Hmnd B3 07	57. Tron Str/Chr	100. Hmnd B3 12
15. Hmnd B3 08	58. Tron Str/Brs	101. Syn Bass 01
16. Hmnd B3 09	59. CP Grand 02	102. Soft Pad 01
17. Hmnd B3 10	60. CP Grand 03	103. Hard Pad 01
18. Hmnd B3 11	61. CP Grand 04	104. Syn Lead 01
19. Fndr Rds 02	62. CP Grand 05	105. Intrvl Ld 01
20. Fndr Rds 03	63. CP Grand 06	106. Misc Cool 01
21. Fndr Rds 04	64. CP Grand 07	107. Swell FX 01
22. Fndr Rds 05	65. CP Grand 08	108. Clock FX 01
23. Fndr Rds 06	66. CP Grand 09	109. Hmnd B3 13
24. Fndr Rds 07	67. CP Grand 10	110. Hmnd B3 14
25. Fndr Rds 08	68. CP Grand 11	111. Hmnd B3 15
26. Fndr Rds 09	69. Bass: Moog 02	112. Hmnd B3 16
27. Fndr Rds 10	70. Bass: Moog 03	113. Hmnd B3 17
28. Fndr Rds 11	71. Bass: Moog 04	114. Hmnd B3 18
29. Wurli 02	72. Bass: Moog 05	115. Hmnd B3 19
30. Wurli 03	73. Bass: Moog 06	116. Hmnd B3 20
31. Wurli 04	74. Bass: MicroMg	117. Hmnd B3 21
32. Wurli 05	75. Bass: Taurus	118. Hmnd B3 22
33. Wurli 06	76. Bass: M12 01	119. Syn Bass 02
34. Wurli 07	77. Bass: M12 02	120. Syn Bass 03
35. Wurli 08	78. Bass: Arp2600	121. Syn Bass 04
36. Wurli 09	79. Pad: MoogBras	122. Syn Bass 05
37. Wurli 10	80. Pad: P5String	123. Syn Bass 06
38. Wurli 11	81. Pad: M12Strng	124. Syn Bass 07
39. Clav 02	82. Pad: ArpStrng	125. Syn Bass 08
40. Clav 03	83. Pad: Obx Saws	126. Syn Bass 09
41. Clav 04	84. Pad: Arp 2600	127. Syn Bass 10
42. Clav 05	85. Pad: PolyMoog	

128. Syn Bass 11	171. Misc Cool 04	214. Elec Gtr 02
129. Soft Pad 02	172. Misc Cool 05	215. Elec Gtr 03
130. Soft Pad 03	173. Misc Cool 06	216. Elec Gtr 04
131. Soft Pad 04	174. Misc Cool 07	217. Bass/Guitar
132. Soft Pad 05	175. Misc Cool 08	218. CoolLink 11a
133. Soft Pad 06	176. Misc Cool 09	219. CoolLink 11b
134. Soft Pad 07	177. Misc Cool 10	220. Super Nova
135. Soft Pad 08	178. Misc Cool 11	221. TronBrasLink
136. Soft Pad 09	179. Swell FX 02	222. HiBarLink L
137. Soft Pad 10	180. Swell FX 03	223. HiBarLink M
138. Soft Pad 11	181. Swell FX 04	224. HiBarLink S
139. Hard Pad 02	182. Swell FX 05	225. MidBarLink L
140. Hard Pad 03	183. Swell FX 06	226. MidBarLink M
141. Hard Pad 04	184. Swell FX 07	227. MidBarLink S
142. Hard Pad 05	185. Swell FX 08	228. LoBarLink L
143. Hard Pad 06	186. Swell FX 09	229. LoBarLink M
144. Hard Pad 07	187. Swell FX 10	230. LoBarLink S
145. Hard Pad 08	188. Swell FX 11	231. 2ndPercLink L
146. Hard Pad 09	189. Clock FX 02	232. 2ndPercLinkM
147. Hard Pad 10	190. Clock FX 03	233. 2ndPercLink S
148. Hard Pad 11	191. Clock FX 04	234. 3rdPercLink L
149. Syn Lead 02	192. Clock FX 05	235. 3rdPercLink M
150. Syn Lead 03	193. Clock FX 06	236. 3rdPercLink S
151. Syn Lead 04	194. Clock FX 07	237. B3 12 Link A
152. Syn Lead 05	195. Clock FX 08	238. B3 12 Link B
153. Syn Lead 06	196. Clock FX 09	239. Swell 3 Link
154. Syn Lead 07	197. Clock FX 10	240. - default -
155. Syn Lead 08	198. Clock FX 11	241. - default -
156. Syn Lead 09	199. Clock FX 12	242. - default -
157. Syn Lead 10	200. Drum Kit 01	243. - default -
158. Syn Lead 11	201. Drum Kit 02	244. - default -
159. Intrvl Ld 02	202. Drum Kit 03	245. - default -
160. Intrvl Ld 03	203. Drum Kit 04	246. - default -
161. Intrvl Ld 04	204. Drum Kit 05	247. - default -
162. Intrvl Ld 05	205. Drum Kit 06	248. - default -
163. Intrvl Ld 06	206. Drum Kit 07	249. - default -
164. Intrvl Ld 07	207. Perc Loop	250. - default -
165. Intrvl Ld 08	208. Bass Gtr 01	251. - default -
166. Intrvl Ld 09	209. Bass Gtr 02	252. - default -
167. Intrvl Ld 10	210. Bass Gtr 03	253. - default -
168. Intrvl Ld 11	211. Bass Gtr 04	254. - default -
169. Misc Cool 02	212. Bass Gtr 05	255. - default -
170. Misc Cool 03	213. Elec Gtr 01	

••• **Linked Presets** are used as part of another preset.

••• Store your own custom presets in the **Default** preset locations.

# FACTORY PRESETS - ROM

## Vintage Keys Presets

0-255 RAM

256-511 ROM

••• Linked Presets are used  
as a part of another preset.

256. Hmnd B3	23	299. Soft Pad	22	342. Soft Pad	26
257. Fndr Rds	12	300. Hard Pad	14	343. Soft Pad	27
258. Wurli	12	301. Hard Pad	15	344. Syn Bass	16
259. Soft Pad	12	302. Syn Lead	13	345. Percussion	3
260. TronStrng	04	303. Hard Pad	16	346. Hmnd Link	A
261. Hard Pad	12	304. Bass Gtr.	06	347. Soft Pad	28
262. Syn Lead.	12	305. Percussion	2	348. Soft Pad	29
263. Soft Pad.	13	306. Hmnd B3	27	349. Soft Pad	30
264. Syn Bass	12	307. CP Grand	13	350. Soft Pad	31
265. Drum Kit	08	308. Vox Cont	01	351. Percussion	4
266. Farfisa		309. Clock FX	14	352. Syn Lead	16
267. Hard Pad	13	310. Syn Lead	14	353. Hmnd Link	B
268. Wurli	13	311. Swell FX	14	354. Syn Bass	17
269. Soft Pad	14	312. Swell FX	15	355. Hmnd Link	C
270. Clock FX	13	313. Elec Gtr	05	356. Hmnd B3	35
271. Swell FX	12	314. Syn Bass	15	357. TronStrng	05
272. Intrvl Ld	12	315. Drum Kit	11	358. Drum Link	C
273. Swell FX	13	316. Hmnd B3	28	359. Drum Link	D
274. Syn Bass	13	317. Clav	15	360. Drum Link	E
275. Drum Kit	09	318. Hmnd B3	29	361. Percussion	5
276. Hmnd B3	24	319. Syn Lead	15	362. Hmnd B3	36
277. Wurli	14	320. Hmnd B3	30	363. Hard Pad	21
278. Clav	12	321. Hmnd B3	31	364. Syn Bass	18
279. TronFlute	04	322. Hmnd B3	32	365. Syn Bass	19
280. TronChoir	04	323. Fndr Rds	14	366. Syn Bass	20
281. Soft Pad	15	324. Clock FX	15	367. Syn Bass	21
282. Soft Pad	16	325. Swell FX	16	368. Hmnd B3	37
283. Soft Pad	17	326. Hmnd B3	33	369. Hard Pad	22
284. Syn Bass	14	327. Hard Pad	17	370. Percussion	6
285. Drum Kit	10	328. CP Grand	14	371. Hmnd B3	40
286. Hmnd B3	25	329. Hard Pad	18	372. Hmnd B3	41
287. CP Grand	12	330. Misc Cool	13	373. Hmnd Link	D
288. Toy Piano		331. Soft Pad	23	374. Hmnd B3	42
289. Soft Pad	18	332. Drum Kit	12	375. Hmnd Link	E
290. Soft Pad	19	333. Drum Link	A	376. Hmnd Link	F
291. Misc Cool	12	334. Drum Link	B	377. Hmnd B3	43
292. Soft Pad	20	335. Drum Kit	13	378. Hmnd B3	44
293. Soft Pad	21	336. Hmnd B3	34	379. Hmnd Link	G
294. Clav	13	337. Wurli	15	380. Hmnd B3	45
295. Percussion	1	338. Soft Pad	24	381. Hmnd Link	H
296. Hmnd B3	26	339. Soft Pad	25	382. Hmnd B3	46
297. Clav	14	340. Hard Pad	19	383. —default—	
298. Fndr Rds	13	341. Hard Pad	20		

384. Link to 419		427. Soft Pad	33	470. SBas2 4Split
385. Bass Gtr	07	428. Soft Pad	34	471. SBas3 4Split
386. Bass Gtr	08	429. Soft Pad	35	472. SBas4 4Split
387. Percussion	7	430. Soft Pad	36	473. SBas5 4Split
388. Percussion	8	431. Soft Pad	37	474. SBas4/Lead1
389. Drum Kit	14	432. Soft Pad	38	475. BGtr1/Lead2
390. Drum Kit	15	433. Soft Pad	39	476. BGtr3/Lead3
391. Drum Kit	16	434. Soft Pad	40	477. Pad5/Lead4
392. Drum Kit	17	435. Syn Bass	22	478. Orgn10/Lead5
393. Drum Kit	18	436. Syn Bass	23	479. Pad7/Lead6
394. Drum Kit	19	437. Syn Bass	24	480. Pad8/Lead7
395. Clock FX	16	438. Syn Bass	25	481. Pad2/Lead8
396. Clock FX	17	439. Syn Bass	26	482. BGtr3/Pad1
397. Clock FX	18	440. Syn Bass	27	483. BGtr2/Pad2
398. Clock FX	19	441. Syn Lead	17	484. SBas3/Pad3
399. Clock FX	20	442. Syn Lead	18	485. BGtr1/Pad4
400. Clock FX	21	443. Syn Lead	19	486. Pad5/Pad6
401. Misc Cool	14	444. Syn Lead	20	487. Pad3/Pad6
402. Misc Cool	15	445. Syn Lead	21	488. SBas4/Pad7
403. Misc Cool	16	446. Syn Lead	22	489. BGtr1/Pad8
404. Misc Cool	17	447. Syn Lead	23	490. SBas2/Pad9
405. Misc Cool	18	448. TronChoir	05	491. Pad10/Lead2
406. Misc Cool	19	449. TronChoir	06	492. Pad11/Lead1
407. Misc Cool	20	450. TronStrng	06	493. SBas5/Pad12
408. Musical Box		451. Wurli	16	494. BGtr3/CP-01
409. Swell FX	17	452. Wurli	17	495. BGtr4/CP-02
410. Swell FX	18	453. Hmnd B3	46	496. BGtr3/CP-03
411. Swell FX	19	454. Hmnd B3	47	497. BGtr2/ElPno1
412. Clav	16	455. Hmnd B3	48	498. BGtr3/ElPno2
413. CP Grand	15	456. Hmnd B3	49	499. BGtr3/ElPno3
414. CP Grand	16	457. Rococo Hair		500. BGtr3/ElPno4
415. CP Grand	17	458. Rococo Link		501. BGtr2/Orgn01
416. CP Grand	18	459. Hmnd Link	J	502. BGtr1/Orgn02
417. Hard Pad	23	460. Hmnd Link	K	503. BGtr3/Orgn03
418. Hard Pad	24	461. OrgSpltLinkA		504. BGtr2/Orgn04
419. Hard Pad	25	462. OrgSpltLinkB		505. BGtr1/Orgn05
420. Hard Pad	26	463. OrgSpltLinkC		506. SBas3/Orgn06
421. Hard Pad	27	464. BGtr1 4Split		507. BGtr3/Orgn07
422. Hard Pad	28	465. BGtr2 4Split		508. BGtr3/Orgn08
423. Hard Pad	29	466. BGtr3 4Split		509. BGtr3/Orgn09
424. Hard Pad	30	467. BGtr4 4Split		510. BGtr3/Orgn10
425. Hard Pad	31	468. BGtr5 4Split		511. - default -
426. Soft Pad	32	469. SBas1 4Split		



## SAMPLED SOUNDS

1. B3DistLwSlw ..... Distorted B3 Organ, Low Drawbars, Slow Rotor
2. B3 Dist Fast ..... Distorted B3 Organ, Fast Rotor
3. B3 Hi Slow ..... B3 Organ, High Drawbars, Slow Rotor
4. B3 Hi Fast ..... B3 Organ, High Drawbars, Fast Rotor
5. B3 Full Slow ..... B3 Organ, Full Drawbars, Slow Rotor
6. B3 Full Fast ..... B3 Organ, Full Drawbars, Fast Rotor
7. B3 Perc 3rd ..... B3 Organ 3rd Harmonic Percussion
8. Male Choir ..... Mellotron - Male Choir
9. Femme Choir ..... Mellotron - Female Choir
10. Males to Mix ..... Mellotron - Male Choir (to mix with Inst. 11)
11. Femmes to Mix ..... Mellotron - Female Choir (to mix with Inst. 10)
12. Violin Trio ..... Mellotron - Violins
13. Flute ..... Mellotron - Flute
14. Bari Sax ..... Baritone Saxophone
15. Tenor Sax ..... Tenor Saxophone
16. Alto Sax ..... Alto Saxophone
17. Trumpet Sft ..... Soft-blown Trumpet
18. Trumpet Sft ..... Hard-blown Trumpet
19. Trombone ..... Trombone
20. Trom/STpt ..... Trombone/Soft Trumpet Split
21. Trom/HTpt ..... Trombone/Hard Trumpet Split
22. Trom/Sax ..... Trombone/Sax Split
23. Farfisa ..... Farfisa Organ
24. CP-70 ..... CP-70 Piano
25. CP-70 Mellow ..... CP-70 Piano with Mellow Tone
26. CP-70 Brite ..... CP-70 Piano with Bright Tone
27. Piano Bass ..... CP-70 Piano Bass - Transposed
28. Wurlitzer1 ..... Wurlitzer Electric Piano 1
29. Wurlitzer2 ..... Wurlitzer Electric Piano 2
30. Dyno Rhodes1 ..... Dyno-My-Rhodes Electric Piano 1
31. Dyno Rhodes2 ..... Dyno-My-Rhodes Electric Piano 2
32. FendrRhodes ..... Fender Rhodes Electric Piano
33. Clavinet ..... Hohner Clavinet
34. Brite Clavinet ..... Bright Hohner Clavinet

- 35. Mini Moog 1 ..... Mini Moog w/Low Resonance
- 36. Mini Moog 2 ..... Mini Moog w/ Med Resonance
- 37. Mini Moog 3 ..... Mini Moog w/High Resonance
- 38. Mini Moog 4 ..... Mini Moog w/Lower Cutoff
- 39. Mini Moog 5 ..... Mini Moog Horn Sound
- 40. Mini Moog 6 ..... Mini Moog w/Osc->Filter Modulation
- 41. Micro Moog ..... Micro Moog w/ Osc->Filter Modulation
- 42. Taurus Pedal ..... Moog Taurus Bass Pedal
- 43. Jaco Bass ..... DX-7 Bass Sound
- 44. M12 Lead 1 ..... Oberheim Matrix-12 Sync Patch 1
- 45. M12 Lead 2 ..... Matrix-12 Sync Patch 2
- 46. ARP 2600 ..... ARP 2600 Synth w/ Osc->Filter Modulation
- 47. Rock DXman ..... DX-7 played through Rockman
- 48. P5 Sync Lead ..... Prophet-5 Sync Patch
- 49. Moog 55 Rez ..... Moog Model 55 w/ Filter Resonance
- 50. Memory Moog ..... Memory Moog - Horn Patch
- 51. OBX Saws ..... Oberheim OBX - Sawtooth Patch
- 52. P5 Guitar Pad ..... Prophet-5 - Guitar-like Patch
- 53. Matrix Pad ..... Matrix-12 - Hollow Patch
- 54. P5 Piper ..... Prophet-5 - Overblown Pipe Patch
- 55. P5 Strings ..... Prophet-5 - String Patch
- 56. M12 Strings ..... Matrix-12 - String Patch
- 57. ARP Strings ..... ARP String Ensemble
- 58. AHHs ..... Fairlight Vocals
- 59. Picked Bass ..... Picked Bass Guitar
- 60. Finger Bass ..... Fingerpicked Bass Guitar
- 61. Finger Tre ..... Fingerpicked Bass Guitar
- 62. Pickd 8 Top ..... 8-String Bass Guitar
- 63. Finger 8 Top ..... 8-String Bass Guitar
- 64. Finger 8 Tre ..... 8-String Bass Guitar
- 65. The Guitar ..... Clean Electric Guitar
- 66. Twelve Top 1 ..... 12-String Guitar
- 67. Twelve Top 2 ..... 12-String Guitar
- 68. Twelve Top 3 ..... 12-String Guitar

- 69. Drum Kit 1 .....
- 70. Drum Kit 2 .....
- 71. Drum Kit 3 .....
- 72. Drum Kit 4 .....
- 73. Drum Kit 5 .....
- 74. Drum Kit 6 .....
- 75. Drum Kit 7 .....

See the **Percussion Instrument Location Diagrams** on pages 98-100.

- 76. Large Hall .....
- 77. Medium Room .....
- 78. Tiled Room .....
- 79. Gated Short .....
- 80. Gated Long 1 .....
- 81. Gated Long 2 .....
- 82. Lush Reverb .....
- 83. Blush Reverb .....
- 84. Full On Reverb .....

**Reverb Spaces** to combine with Drum Kits 1-7.

See the **Reverb Space Diagram** on page 100.

- 85. Dry Kick ..... Dry Kick Drum over the full keyboard range
- 86. Kick Verb ..... Kick Drum Reverb over the full keyboard range
- 87. Dry Snare ..... Dry Snare Drum over the full keyboard range
- 88. Snare Verb ..... Snare Drum Reverb over the full keyboard range
- 89. Dry Tom ..... Dry Tom Tom over the full keyboard range
- 90. Wet Tom ..... Ambient Tom Tom over the full keyboard range
- 91. High Hat 1 ..... Closed Hi-Hat over the full keyboard range
- 92. High Hat 2 ..... Half Closed Hi-Hat over the full keyboard range
- 93. High Hat 3 ..... Open Hi-Hat over the full keyboard range
- 94. Ride Ping ..... Ride Cymbal Ping over the full keyboard range
- 95. Ride Bell ..... Ride Cymbal Bell over the full keyboard range
- 96. Crash ..... Crash Cymbal over the full keyboard range
- 97. Cowbell ..... Cowbell over the full keyboard range
- 98. Tambourine ..... Tambourine over the full keyboard range
- 99. Side Stick ..... Snare Side Stick over the full keyboard range
- 100. Clave ..... Rosewood Clave over the full keyboard range

*\* The names of the above-mentioned instruments may be trademarks of third parties. In order to create the instrument sounds, E-mu records such sound from the respective instrument and the recording is converted into a digital signal which is then modified as necessary to be stored in a read only memory (ROM) device.*

## SYNTHESIZER & ORGAN WAVEFORMS

The single cycle waveforms are sampled waves from various synthesizers and organs. The Moog, ARP & OB waves have been sampled with various filter settings characteristic of each unit.

The B3 waves are various harmonic drawbar settings designed to be used alone or layered together with the multi-cycle organ samples (instruments 1-7). The various drawbar settings were selected to produce an extremely wide degree of variation. See the B3 Wave Drawbar Setting Diagrams on pages 95-97.

- |                       |                   |
|-----------------------|-------------------|
| 101. Square           | 128. OB Wave 5    |
| 102. Sawtooth         | 129. ARP 2600 1   |
| 103. Triangle         | 130. ARP 2600 2   |
| 104. Moog Saw 1       | 131. ARP 2600 3   |
| 105. Moog Saw 2       | 132. B3 Wave 1    |
| 106. Moog Saw 3       | 133. B3 Wave 2    |
| 107. Moog Saw 4       | 134. B3 Wave 3    |
| 108. Moog Square 1    | 135. B3 Wave 4    |
| 109. Moog Square 2    | 136. B3 Wave 5    |
| 110. Moog Square 3    | 137. B3 Wave 6    |
| 111. Moog Square 4    | 138. B3 Wave 7    |
| 112. Moog Square 5    | 139. B3 Wave 8    |
| 113. Moog Square 6    | 140. B3 Wave 9    |
| 114. Moog Rectangle 1 | 141. B3 Wave 10   |
| 115. Moog Rectangle 2 | 142. B3 Wave 11   |
| 116. Moog Rectangle 3 | 143. B3 Wave 12   |
| 117. Moog Rectangle 4 | 144. B3 Wave 13   |
| 118. Moog Rectangle 5 | 145. B3 Wave 14   |
| 119. Moog Pulse 1     | 146. B3 Wave 15   |
| 120. Moog Pulse 2     | 147. B3 Wave 16   |
| 121. Moog Pulse 3     | 148. B3 Wave 17   |
| 122. Moog Pulse 4     | 149. B3 Wave 18   |
| 123. Moog Pulse 5     |                   |
| 124. OB Wave 1        | 150. ARP Clarinet |
| 125. OB Wave 2        | 151. ARP Bassoon  |
| 126. OB Wave 3        | 152. P5 No-Tone   |
| 127. OB Wave 4        | 153. Noise Non-X  |

**HARMONIC WAVEFORMS**

- 154. Oct 1 (Sine)
- 155. Oct 2 All
- 156. Oct 3 All
- 157. Oct 4 All
- 158. Oct 5 All
- 159. Oct 6 All
- 160. Oct 7 All
- 161. Oct 2 Odd
- 162. Oct 3 Odd
- 163. Oct 4 Odd
- 164. Oct 5 Odd
- 165. Oct 6 Odd
- 166. Oct 7 Odd
- 167. Oct 2 Even
- 168. Oct 3 Even
- 169. Oct 4 Even
- 170. Oct 5 Even
- 171. Oct 6 Even
- 172. Oct 7 Even
- 173. Low Odds
- 174. Low Evens
- 175. Four Octaves

Starting from the first octave (fundamental), the harmonic waveforms contain the harmonics (odd, even, or all) present in each octave. In each successive octave, the number of harmonics doubles. By combining (pri/sec or link) the harmonic waveforms in various amounts (volume), and transposing them (course/fine tuning), a wide range of timbres may be produced.

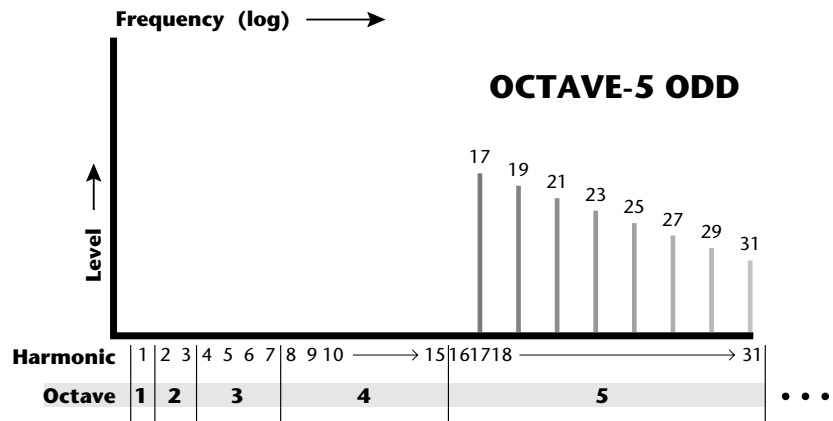

As an example, this chart shows the harmonics present in the *Octave 5 Odd* waveform.

**SINGLE CYCLE WAVEFORMS**

These single cycle waveforms were either synthesized or taken from actual sampled sounds. Each wave has a unique tonal quality.

- |                         |                   |
|-------------------------|-------------------|
| 176. Synth Cycle 1      | 204. Power 5ths   |
| 177. Synth Cycle 2      | 205. Filter Saw   |
| 178. Synth Cycle 3      | 206. Ramp         |
| 179. Synth Cycle 4      | 207. Evens Only   |
| 180. Fundamental Gone 1 | 208. Odds Gone    |
| 181. Fundamental Gone 2 | 209. Ice Bell     |
| 182. Bite Cycle         | 210. Bronze Age   |
| 183. Buzzy Cycle        | 211. Iron Plate   |
| 184. Metalphone 1       | 212. Aluminum     |
| 185. Metalphone 2       | 213. Lead beam    |
| 186. Metalphone 3       | 214. Steel Xtract |
| 187. Metalphone 4       | 215. Winter Glass |
| 188. Duck Cycle 1       | 216. Town bell    |
| 189. Duck Cycle 2       | 217. Orch Bells   |
| 190. Duck Cycle 3       | 218. Tubular SE   |
| 191. Wind Cycle 1       | 219. Soft Bell    |
| 192. Wind Cycle 2       | 220. Swirly       |
| 193. Wind Cycle 3       | 221. Tack Attack  |
| 194. Wind Cycle 4       | 222. Shimmer Wave |
| 195. Organ Cycle 1      | 223. Mild Tone    |
| 196. Organ Cycle 2      | 224. Ah Wave      |
| 197. Violin Essence     | 225. Vocal Wave   |
| 198. Buzzoon            | 226. Fuzzy Clav   |
| 199. Brassy Wave        | 227. Electrhode   |
| 200. Reedy Buzz         | 228. Whine 1      |
| 201. Growl Wave         |                   |
| 202. HarpsiWave         |                   |
| 203. Fuzzy Gruzz        |                   |

### MULTI-CYCLE WAVEFORMS

- 229. Filter Bass
- 230. Harmonics
- 231. ElecPiano
- 232. Marimba Attack
- 233. Vibe Attack
- 234. Xposed Noise

### LOOPS AND PILES

- 235. Marimba Loop
- 236. Vibes Loop
- 237. Stick Loop
- 238. Cowbell Loop
- 239. Clave Loop
- 240. Hi Hat Loop
- 241. Drum Pile
- 242. CP-70 Pile
- 243. Pick Bass Pile
- 244. Guitar Pile
- 245. Finger Bass Pile
- 246. Moog Loop
- 247. OB Loop
- 248. Frost Loop
- 249. Memory Loop

**Loops** are single samples continuously looped.

**Piles** are continuous loops containing multiple samples.

Loops and Piles are useful for special effects and can provide rhythmic accompaniment when chords are played. Extreme transpositions can also yield unusual effects.

**DRAWBAR DIAGRAMS**

Each drawbar controls the volume of its associated harmonic or overtone. The 8' drawbar is the fundamental pitch of the sound. Note that instruments 1-7 are full length samples while waves 1-18 are single cycle loops.

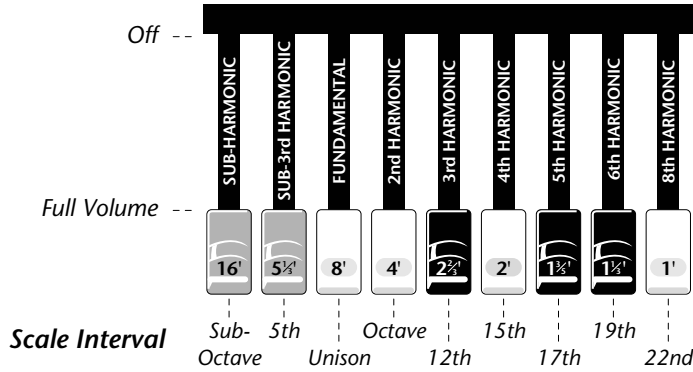

**Instruments 1 & 2**

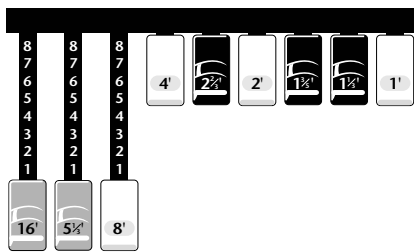

**Instruments 3 & 4**

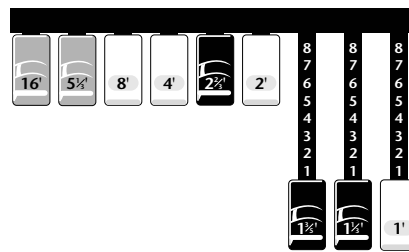

**B3 Wave 1**

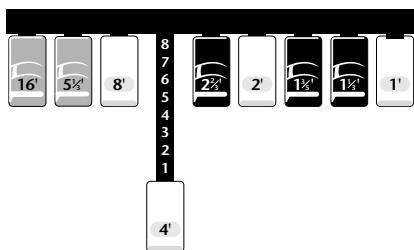

**B3 Wave 2**

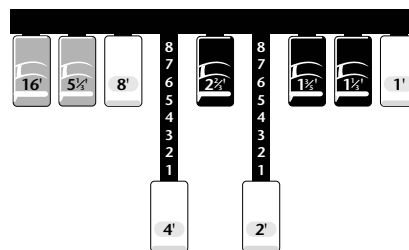

**B3 Wave 4**

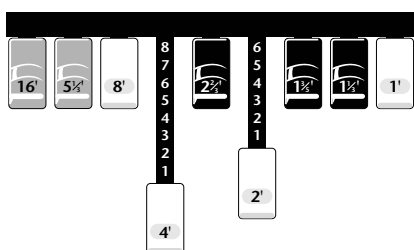

**B3 Wave 3**

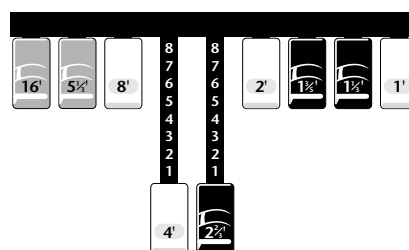

••• You can add animation to the single cycle waves by modulating their pitch or volume with the LFO.



# B3 WAVES - DRAWBAR SETTINGS

**B3 Wave 5**

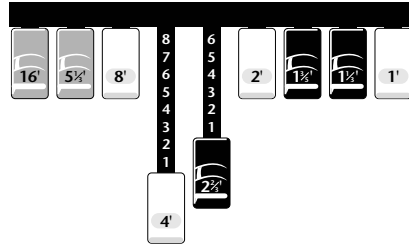

**B3 Wave 6**

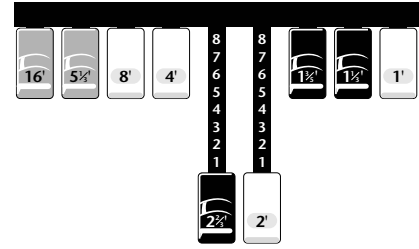

**B3 Wave 7**

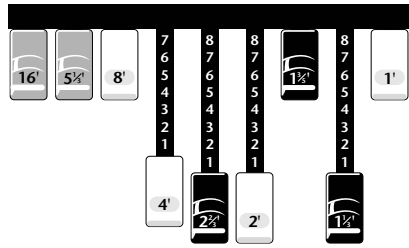

**B3 Wave 8**

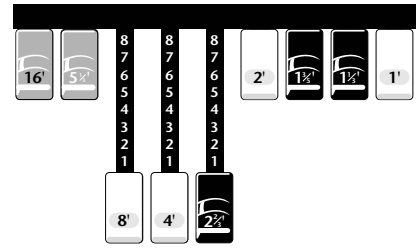

**B3 Wave 9**

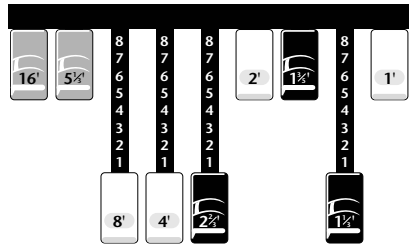

**B3 Wave 10**

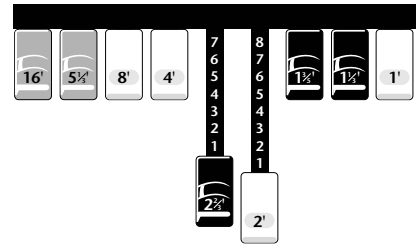

**B3 Wave 11**

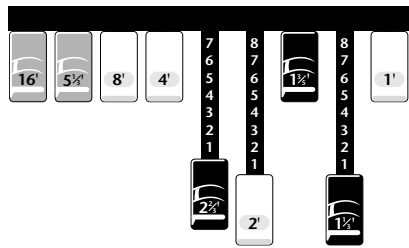

**B3 Wave 12**

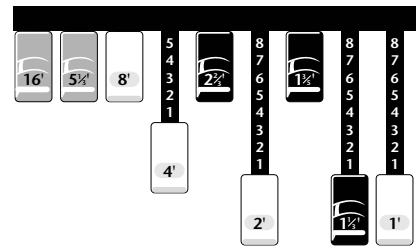

B3 Wave 13

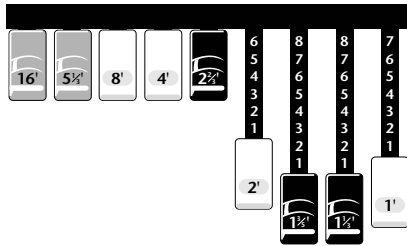

B3 Wave 14

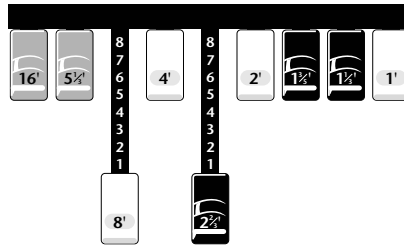

B3 Wave 15

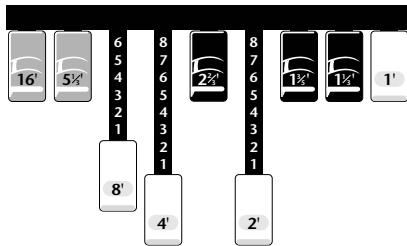

B3 Wave 16

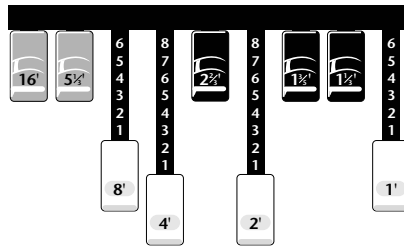

B3 Wave 17

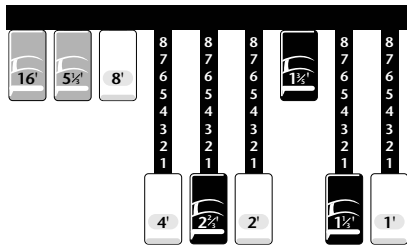

B3 Wave 18

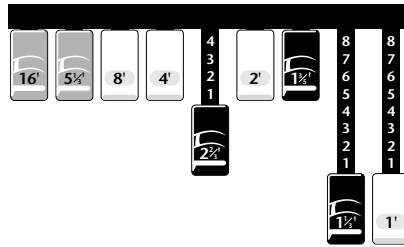

# PERCUSSION INSTRUMENT LOCATIONS

## ALL DRUMS

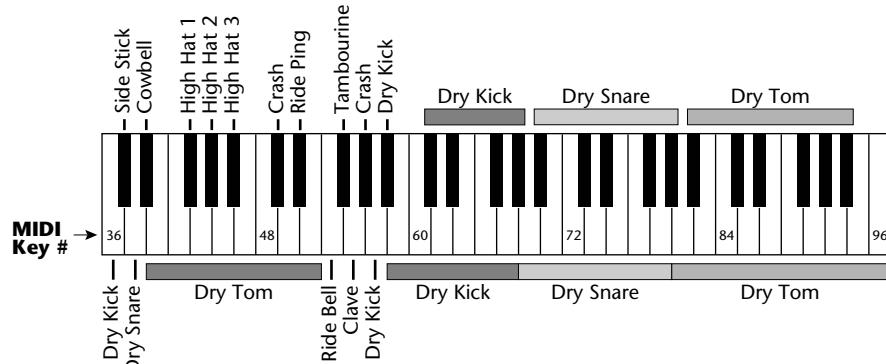

**Drum Kit 1**  
Instrument 69

## SNARE EMPTY

Allows you to place a tuned snare (inst. #87) in this location using the secondary layer.

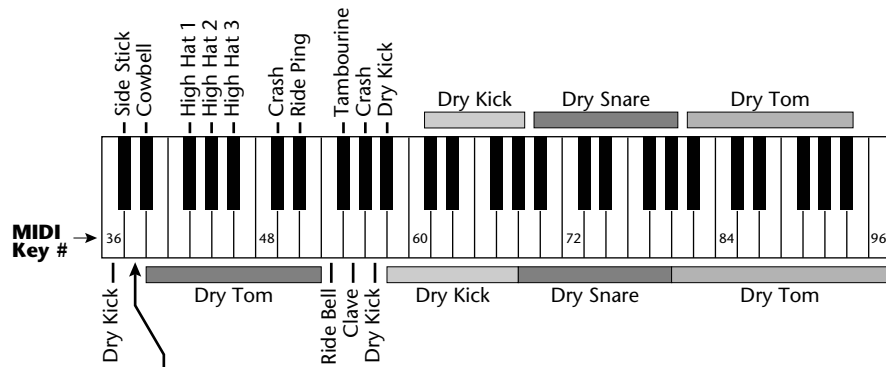

**Snare left Empty**

**Drum Kit 2**  
Instrument 70

## KICK & SNARE EMPTY

Allows you to place tuned kick & snares (inst. 85 & 87) in these locations using the secondary layer or links.

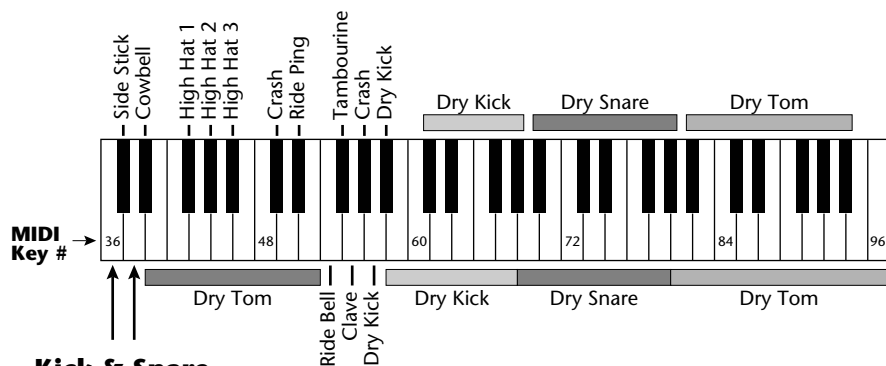

**Kick & Snare left Empty**

**Drum Kit 3**  
Instrument 71

# PERCUSSION INSTRUMENT LOCATIONS

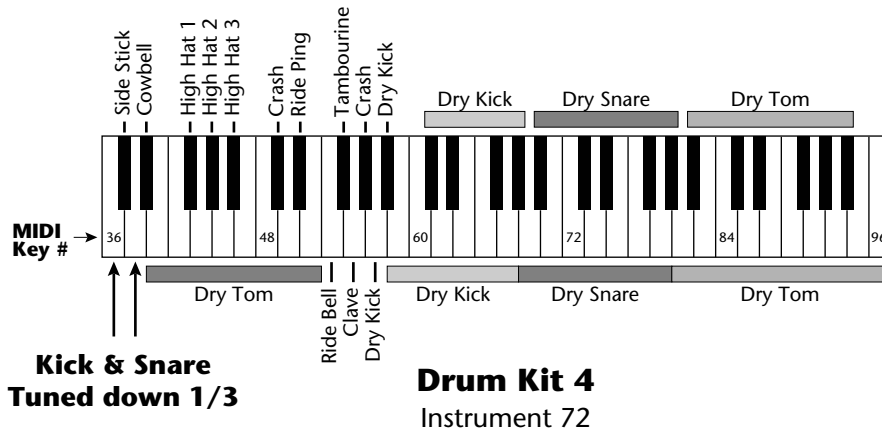

**KICK & SNARE  
TUNED DOWN**

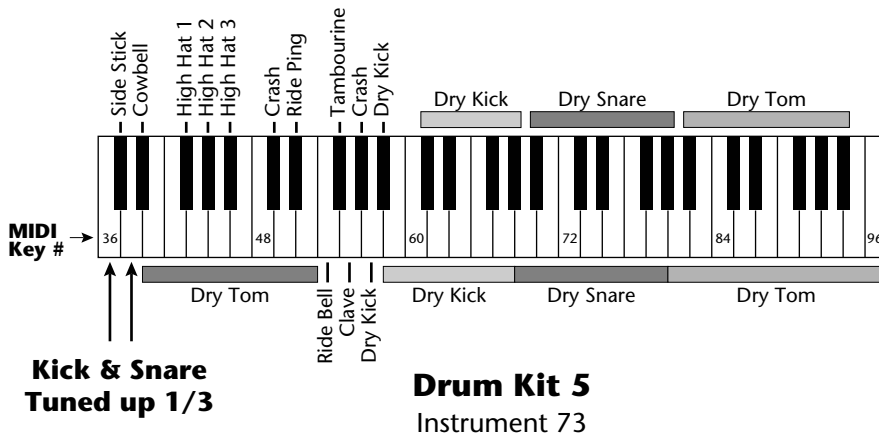

**KICK & SNARE  
TUNED UP**

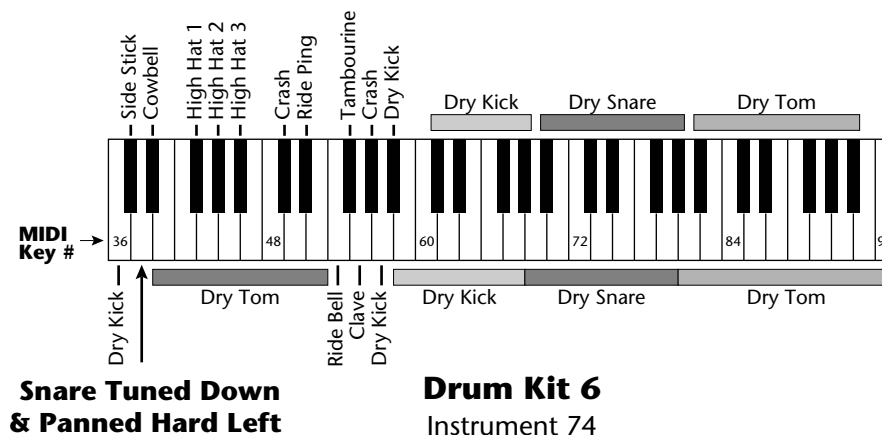

**SNARE TUNED  
DOWN,  
PANNED LEFT**

Allows you to create a stereo snare by panning the secondary snare hard right.  
*(Hint: use delay, tuning, sound start.)*

# PERCUSSION INSTRUMENT LOCATIONS

## SNARE PANNED LEFT

Allows you to create a stereo snare by panning the secondary snare hard right.  
 (Hint: use delay, tuning, sound start.)

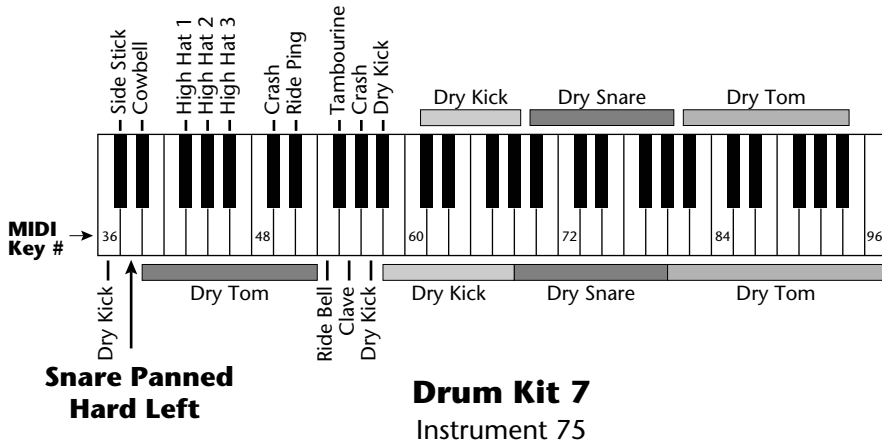

## REVERB SPACES

Allows you to add reverb by layering with Drum Kits 1-7.

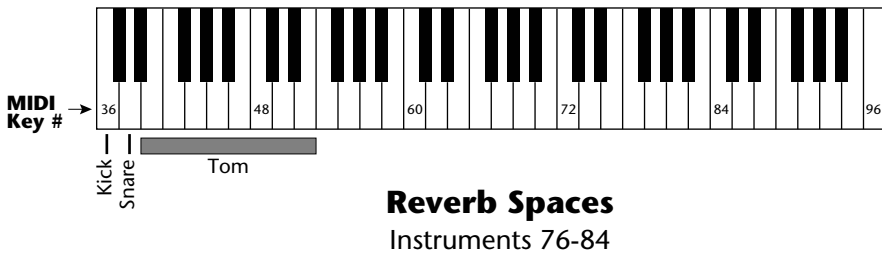

••• For more information on the Reverb Spaces, see the Practice Programming section of this manual.

**Audio Channels:** ..... 32  
**Audio Outputs:** ..... 6 (2 main, 4 submix)  
**Submix Inputs:** ..... 4  
**Max. Output Level:** ..... +4 dB into 600Ω  
**Output Impedance:** ..... 1KΩ  
**MIDI:** ..... In, Out, Thru  
**Data Encoding:** ..... 16 bit Linear  
**Sample Playback Rate:** ..... 39 kHz  
**Signal to Noise:** ..... >90 dB  
**Dynamic Range:** ..... >90 dB  
**Frequency Response:** ..... 20 Hz-15 kHz  
**THD +N:** ..... <.05%  
**IMD:** ..... <.05%  
**Stereo Phase:** ..... Phase Coherent ±1° at 1 kHz  
  
**Power Requirements:** ..... 25 watts  
**Dimensions:** ..... H: 1.75" W: 19" L: 8.5"  
**Weight:** ..... 6 lb, 14 oz (3.1 Kg)

# MIDI IMPLEMENTATION CHART

Function...		Transmitted	Recognized	Remarks
Basic Channel	Default Changed	No No	1 1-16	Memorized
Mode	Default Messages	Yes	Mode 1, 3, 4 MONO, POLY OMNI, ON/OFF	Memorized
Note Number	True Voice	No No	0-127 0-127	
Velocity	Note ON Note OFF	No No	Yes v=1-127 No	
After Touch	Keys Channels	No No	Yes Yes	
Pitch Bender		No	Yes	
Control Change		No	Yes	0-31 64-79
Program Change	True Number	No No	Yes 0-127 Yes 0-127	
All Sound Off		No	Yes	
All Notes Off		No	Yes	
Reset All Controllers		No	Yes	
System Exclusive		Yes	Yes	
System Common	:Song Pos :Song Sel :Tune	No No No	No No No	
System Real Time	:Clock :Commands	No No	No No	
Aux Messages	:Local On/Off :Active Sense :Reset	No No No	No No No	
<p><b>Notes:</b> Pan 0=hard left 127=hard right            Mode 1: OMNI ON, POLY    Mode 2: OMNI ON, MONO            Mode 3: OMNI OFF, POLY    Mode 4: OMNI OFF, MONO</p>				

## GENERAL INFORMATION FOR VINTAGE KEYS SYSEX

- Product ID for Vintage Keys is **0A**.
- Device ID is [00-0F] (0-15 decimal).
- Parameter Number and Parameter Value are 2 bytes each.
- Since MIDI data bytes cannot be greater than [7F] (127 decimal), the data values are “nibble-ized” to a 14-bit signed 2's complement format.
- There is only one edit buffer which is for the current preset (the preset shown in the display). Only one preset at a time can be edited via SysEx commands and changing the current preset erases the edit buffer.

## RECEIVED CHANNEL COMMANDS

Channels number (n) = 0-15. Message bytes are represented in hex. All other numbers are decimal. Running Status is supported.

<b>Command</b>	<b>Message</b>	<b>Comments</b>
Note Off	8n kk vv	release velocity is ignored
Note On	9n kk vv	velocity 0 = note off
Key Aftertouch	An kk vv	kk = 0-127 vv = 0-127
Program Change	Cn vv	0-127
Channel Aftertouch	Dn vv	0-127
Pitch Bend	En ll mm	l = lsb, m = msb
Realtime Controller	Bn cc vv	cc = 00-31
Footswitch	Bn cc vv	cc = 64-79, vv ≥ 64 = on
Volume	Bn 07 vv	0-127
Pan	Bn 0A vv	0 = hard left, 127 = hard right
All Sound Off	Bn 78 00	turns all sound off
Reset All Controllers	Bn 79 00	ignored in omni mode
All Notes Off	Bn 7B 00	ignored in omni mode
Omni Mode Off*	Bn 7C 00	forces all notes & controls off
Omni Mode On*	Bn 7D 00	forces all notes & controls off
Mono Mode On ( <i>Poly Off</i> )*	Bn 7E 00	forces all notes & controls off
Poly Mode On ( <i>Mono Off</i> )*	Bn 7F 00	forces all notes & controls off

\* Special Notes:

**From Omni Mode** ... Omni Off turns Poly On.

**From Poly Mode** ..... Omni On turns Omni On; Mono On turns Mono On.

**From Mono Mode** ... Mono Off turns Poly On; Omni On turns Omni On.

**From Multi Mode** ... Omni On turns Omni On; Omni Off or Mono Off turns Poly On; Mono On turns Mono On.

**All other changes have no effect.**



••• *Vintage Keys will receive Proteus presets, but will fill in the extra parameters with default values and set instruments to "None".*

••• *Running Status is supported in Vintage Keys.*

▼ *There is only one edit buffer which is for the current preset (the preset shown in the display). Only one preset at a time can be edited via SysEx commands and changing the current preset erases the edit buffer.*

## MIDI SYSEX COMMANDS

For system exclusive commands, the following format is used:

F0	system exclusive status byte
18	E-mu ID byte
0A	product ID byte ( <i>will also respond to ID 04 - Proteus</i> )
dd	device ID byte
cc	command byte
...	data bytes
F7	EOX

### *SysEx Editing*

Preset and setup parameters may be edited individually using system exclusive commands. The preset being edited is the active preset (the preset on the basic or global channel and the one which is shown in the LCD). The value of a given parameter may be changed by sending a *parameter value* command. The value of a parameter may be read by sending a *parameter value request*, to which the machine will respond by sending back the parameter value. Please note that there is only *one* edit buffer

Two MIDI bytes (lsb, msb) are required for each 14 bit data word. Bits 0-6 are sent first, followed by bits 7-13 in the next MIDI byte. All data words are signed 2's complement values with sign-extension out to the most significant bit (bit 13). This convention applies to all data words, regardless of the parameter's value range.

Preset data may also be transmitted or received in a single block (one complete preset) using system exclusive commands. A *preset data request* may be issued by a host computer, to which the machine will respond sending the data block for the requested preset. Conversely, the computer may send new preset data which will replace the specified preset currently in the machine. Additionally, a front panel command will transmit one or all user presets for backup onto an external sequencer. These presets may be restored by simply playing back the sequence into the machine.

**Warning:** When transferring preset banks and tuning table data back and forth from Vintage Keys to a computer, the data should be recorded as you would a regular sequence. Sending the data in one huge chunk will clog the input buffer on Vintage Keys unless a time period of approximately 100 mS is inserted between each preset.

## RECEIVED SYSTEM EXCLUSIVE COMMANDS

<i>Command</i>	<i>Message</i>	<i>Comments</i>
<b>Preset Data Request</b>	F0 18 0A dd <b>00</b> ll mm F7	ll= preset # lsb mm = msb <b>see note 6</b>
<b>Preset Data</b>	F0 18 0A dd <b>01</b> ll mm ... .. cs F7	cs=checksum
<b>Parameter Value Request</b> <i>msb</i>	F0 18 0A dd <b>02</b> pl pm F7 pl = parameter # lsb pm =	
<b>Parameter Value</b>	F0 18 0A dd <b>03</b> pl pm vl vm F7 pl = parameter # lsb pm = msb vl = value lsb vm = msb	
<b>Tuning Table Request</b>	F0 18 0A dd <b>04</b> F7	<b>see note 7</b>
<b>Tuning Table</b>	F0 18 0A dd <b>05</b> ... .. F7	262 bytes
<b>Program Map Request</b>	F0 18 0A dd <b>06</b> F7	<b>see note 8</b>
<b>Program Map Data</b>	F0 18 0A dd <b>07</b> ... .. F7	262 bytes
<b>Master Setting Request</b>	F0 18 0A dd <b>08</b> F7	
<b>Version Request</b>	F0 18 0A dd <b>0A</b> F7	<b>see note 1</b>
<b>Configuration Request</b>	F0 18 0A dd <b>0C</b> F7	<b>see note 2</b>
<b>Instrument List Request</b>	F0 18 0A dd <b>0E</b> F7	<b>see note 3</b>
<b>Preset List Request</b>	F0 18 0A dd <b>12</b> F7	<b>see note 4</b>
<b>MMA Tuning Dump</b>	F0 <b>7E</b> dd <b>08 01</b> tt <name (16 ascii)> ... F7	<b>see note 5</b>

••• 281 bytes per preset  
(272 data + 9 MIDI header)

**TRANSMITTED SYSTEM EXCLUSIVE COMMANDS**

<i>Command</i>	<i>Message</i>	<i>Comments</i>
<b>Preset Data</b>	F0 18 0A dd <b>01</b> ll mm ... .. CS F7 <i>ll= preset # lsb mm = msb cs = checksum</i>	
<b>Parameter Value</b>	F0 18 0A dd <b>03</b> pl pm vl vm F7 <i>pl = parameter # lsb pm = msb vl = value lsb vm = msb</i>	
<b>Tuning Table</b>	F0 18 0A dd <b>05</b> ... .. F7	<i>TT data = 256 bytes</i>
<b>Program Map Data</b>	F0 18 0A dd <b>07</b> ... .. F7	<b>see note 8</b>
<b>Configuration Message</b>	F0 18 0A dd <b>0D</b> pl pm s1 l1 m1 s2 l2 m2 F7	<b>see note 2</b>
<b>Instrument List</b>	F0 18 0A dd <b>0F</b> (14 bytes per instrument) ... .. F7	<b>see note 3</b>
<b>Preset List</b>	F0 18 0A dd <b>13</b> (13 bytes per preset) ... .. F7	<b>see note 4</b>

• **Note 1 - Version Request**

This command allows identification of machine type and software revision. Vintage Keys will respond to the request with the version data:

F0 18 0A dd **0B** 01 r1 r2 r3 F7

r1, r2, r3 = software revision # in ascii (decimal point between r1 & r2).

• **Note 2 - Configuration Message**

This MIDI command is used to identify the sound sets in a given Vintage Keys. The configuration request command is: F0 18 0A dd **0C** F7

Vintage Keys will respond to this command with the configuration message: F0 18 0A dd **0D** pl pm s1 l1 m1 s2 l2 m2 F7

where pl and pm are the lsb and msb of the total number of presets, s1 and s2 are the ID numbers of the sound sets contained in this unit, and n1=l1, m1 and n2=l2, m2 represent the lsb and msb of the number of instruments in each sound set. If no expansion set is present, s2 will be 7F and n2 will be zero. **Standard Vintage Keys Sound Set = 6.**

- **Note 3 - Instrument List**

This MIDI command allows external software to upload the instrument list as an array of ASCII strings. The instrument list request command is:

F0 18 0A dd **0E** F7

Vintage Keys will respond to this command with the instrument list message:

F0 18 0A dd **0F** (14 bytes per instrument) ... .. F7

The instruments are transmitted in the same order they appear to the user on Vintage Keys. Note that a given instrument's position in this list may be different from its actual number within the sound set.

instrument entry: il im (11 ascii bytes) 00

Each instrument entry in the list consists of the actual instrument number (as defined in "Sound Sets" - note 9) in lsb, msb format, followed by the instrument name (11 ascii characters plus a zero terminator) for a total of 14 (decimal) bytes. The first instrument is #1 as displayed on Vintage Keys. The total number of instrument names is equal to (n1+n2) in the configuration message above.

- **Note 4 - Preset List**

This MIDI command allows external software to upload all preset names as an array of ASCII strings. The preset list request command is:

F0 18 0A dd **12** F7

Vintage Keys will respond to this command with the preset list message:

F0 18 0A dd **13** (13 bytes per preset) ... .. F7

Each preset name is 12 ascii characters, plus a zero terminator, for a total of 13 (decimal) bytes. The first preset is #0. The total number of preset names is equal to pp in the configuration message above.

## • Note 5 - Bulk Tuning Dump

Vintage Keys can receive MIDI Tuning Standard dumps in addition to its own SysEx tuning table dumps. Vintage Keys will *only* transmit in it's own SysEx tuning format. The MIDI Tuning Standard is as follows:

F0 7E **dd** 08 01 **tt** <tuning name (16 ascii)> ... F7

**dd**= device ID    **tt**= tuning prog # (ignored)    **tuning name** = (ignored)

... = data (xx yy zz) *frequency data for one note repeated 128x*

xx yy zz = 0xxxxxxx 0abcdefg 0hijklmn

**xxxxxxx** = semitone    **abcdefghijklmn** = fraction of semitone in .0061 cent units. **Examples:** Middle C = 3C 00 00    A-440 = 45 00 00

## • Note 6 - Preset Data Request

Vintage Keys presets are organized into banks. Each bank consists of 64 presets. Vintage Keys has six banks of presets (0-383). Banks may be requested using the preset request command and the appropriate preset code listed below.

<b>Bank</b>	<b>Preset Range</b>	<b>Preset Code</b>	<b>MIDI Message</b>
0	0-63	1024	F0 18 0A dd 00 <b>00 08</b> F7
1	64-127	1025	F0 18 0A dd 00 <b>01 08</b> F7
2	128-191	1026	F0 18 0A dd 00 <b>02 08</b> F7
3	192-255	1027	F0 18 0A dd 00 <b>03 08</b> F7
4	256-319	1028	F0 18 0A dd 00 <b>04 08</b> F7
5	320-383	1029	F0 18 0A dd 00 <b>05 08</b> F7
1	64-127	-1	F0 18 0A dd 00 <b>7F 7F</b> F7
0	0-63	-2	F0 18 0A dd 00 <b>7E 7F</b> F7
0-3	0-255	-3	F0 18 0A dd 00 <b>7D 7F</b> F7
4-5	256-383	-4	F0 18 0A dd 00 <b>7C 7F</b> F7

• **Note 7 - Alternate Tuning**

The “user tuning table” allows any key to be tuned to an arbitrary pitch over an 8 octave range. If selected in the preset, an alternate tuning may be achieved by modifying the tuning values from the front panel or downloading a new table into the machine. The table consists of 128 words, corresponding to the MIDI key range, kept in non-volatile memory. Each word is a pitch value expressed in 1/64 semitones, offset from key number 0 (c-2). Therefore, for equal temperament, each entry in the table would be equal to its key number times 64.

• **Note 8 - Program Mapping**

MIDI program changes will normally correspond to internal preset numbers 0-127. However, the user may “re-map” any MIDI program number, assigning it to an arbitrary internal preset. This feature allows any of the internal presets to be selected from a MIDI keyboard controller. See *Program* → *Preset* on page 21.

**PRESET DATA FORMAT**

Preset data is transmitted and received using the following format: The standard system exclusive header is followed by the preset number (lsb, msb), a 14 bit word for each preset parameter value (lsb, msb) starting at parameter #0 and continuing upward, a one-byte checksum, and the end-of-exclusive byte (F7). The checksum is the modulo 128 sum of all the parameter value bytes; that is, all of the data bytes following the preset number and before the checksum.

**PRESET PARAMETERS**

<b>Parameter No.</b>	<b>Parameter Name</b>	<b>Range</b>	
0-11	preset name (12 ascii characters)	32-127	
12-14	preset link 1-3	0-383	A value of -1 = “Off”
15-18	preset, link 1-3 low key	0-127	
19-22	preset, link 1-3 high key	0-127	
23	pri instrument	0-249	<b>See Note 9</b>
24	pri sound start offset	0-127	
25	pri tuning (coarse)	-36 to +36	
26	pri tuning (fine)	-64 to +64	
27	pri volume	0-127	
28	pri pan	-7 to +7	
29	pri delay	0-127	

## MIDI SPECIFICATIONS

	<i>Parameter No.</i>	<i>Parameter Name</i>	<i>Range</i>
	30	pri low key	0-127
	31	pri high key	0-127
	32	pri alt. volume attack	0-99
	33	pri alt. volume hold	0-99
	34	pri alt. volume decay	0-99
	35	pri alt. volume sustain	0-99
	36	pri alt. volume release	0-99
	37	pri alt. volume envelope on	0-1
	38	pri solo mode	0-2
	39	pri chorus	0-15
	40	pri reverse sound	0-1
<b>See Note 9</b>	41	sec instrument	0-249
	42	sec sound start offset	0-127
	43	sec tuning (coarse)	-36 to +36
	44	sec tuning (fine)	-64 to +64
	45	sec volume	0-127
	46	sec pan	-7 to +7
	47	sec delay	0-127
	48	sec low key	0-127
	49	sec high key	0-127
	50	sec alt. volume attack	0-99
	51	sec alt. volume hold	0-99
	52	sec alt. volume decay	0-99
	53	sec alt. volume sustain	0-99
	54	sec alt. volume release	0-99
	55	sec alt. volume envelope on	0-1
	56	sec solo mode	0-2
	57	sec chorus	0-15
	58	sec reverse sound	0-1
	59	crossfade mode	0-2
	60	crossfade direction	0-1
	61	crossfade balance	0-127
	62	crossfade amount	0-255

<b>Parameter No.</b>	<b>Parameter Name</b>	<b>Range</b>	
63	switch point	0-127	
64	LFO 1 shape	0-4	
65	LFO 1 rate	0-127	
66	LFO 1 delay	0-127	
67	LFO 1 variation	0-127	
68	LFO 1 amount	0-127	
69	LFO 2 shape	0-127	
70	LFO 2 rate	0-127	
71	LFO 2 delay	0-127	
72	LFO 2 variation	0-127	
73	LFO 2 amount	0-127	
74	aux. envelope delay	0-127	
75	aux. envelope attack	0-99	
76	aux. envelope hold	0-99	
77	aux. envelope decay	0-99	
78	aux. envelope sustain	0-99	
79	aux. envelope release	0-99	
80	aux. envelope amount	-128 to +127	
81-86	key/vel source 1-6	0-1	
87-92	key/vel dest 1-6	0-42	<b>See Note 10</b>
93-98	key/vel amount 1-6	-128 to +127	
99-106	realtime source 1-8	0-9	
107-114	realtime dest 1-8	<i>See list</i>	<b>See Note 10</b>
115-117	footswitch dest 1-3	0-10	
118-121	controller amount A-D	-128 to +127	
122	pressure amount	0-127	
123	pitch bend range	0-13	— A value of 13 = "Global"
124	velocity curve	0-5	— A value of 5 = "Global"
125	keyboard center	0-127	
126	submix	0-2	
127	keyboard tuning	0-5	
128	pri portamento rate	0-127	
129	sec portamento rate	0-127	



# MIDI SPECIFICATIONS

<b>Parameter No.</b>	<b>Parameter Name</b>	<b>Range</b>
130	pri filter type	0-2
131	pri filter Fc	0-255
132	pri filter Q	0-15
133	sec filter type	0-2
134	sec filter Fc	0-255
135	sec filter Q	0-15

## GLOBAL/SETUP PARAMETERS

<b>Parameter No.</b>	<b>Parameter Name</b>	<b>Range</b>
256	MIDI basic channel	0-15
257	MIDI volume ( <i>basic channel</i> )	0-127
258	MIDI pan ( <i>basic channel</i> )	-8 to +7
259	current preset ( <i>basic channel</i> )	0-383
260	master tune	-64 to +64
261	transpose	-12 to +12
262	global pitch bend range	0-12
263	global velocity curve	0-4
264	MIDI mode	0-3
265	MIDI overflow	0-1
266-269	controller A-D numbers	0-31
270-272	footswitch 1-3 numbers	0-15
273	mode change enable	0-1
274	device ID number	0-15

A value of -8 = "P"  
 The entire message to set pan to  
 P:  
 F0 18 0A dd 03 02 02 78 7F F7

### Per MIDI Channel

384-399	MIDI channel enable	0-1
400-415	MIDI program change enable	0-1
416-431	mix out	0-3
512-639	MIDI program/preset map	0-383

• **Note 9 - Sound Sets**

A Vintage Keys sound set consists of sample data (sound ROMs), plus additional instrument data in the program ROMs. Each sound set has a unique ID number. The sound set for Vintage Keys is #6.

It is necessary to include the sound set number as part of the instrument number when exchanging data. The complete instrument number contains two fields: bits 8-12 specify the sound set (0-31) and bits 0-7 specify the instrument within the sound set (0-255).

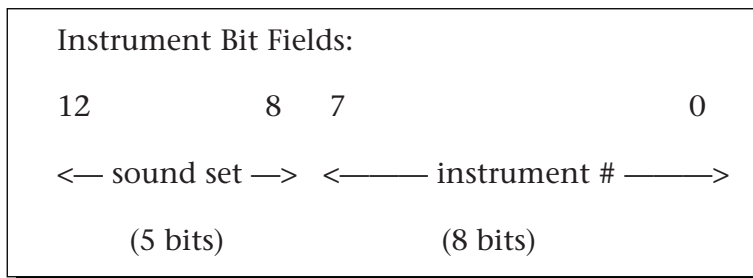

Within any given sound set, the first instrument is #1 and #0 selects “None”.

The “magic number” **1536** represents the start number for the standard Vintage Keys instruments. To calculate the complete instrument number follow the instructions below.

$$\text{SysEx Instr. No.} = 1536 + \text{Vintage Keys Instr. No.}$$

Next you must convert the SysEx instrument number to a 14-bit MIDI number. See the information on the following pages.

**Example:**

Suppose we want to change the instrument to **I002 B3 Dist Fast**.

- 1)  $1536 + 2 = \mathbf{1538}$  ( $1536 + \text{Instr. No.}$ )
- 2)  $1538 \div 128 = 12 \text{ r-}2 = \mathbf{12}$  (ignore remainder)
- 3) 12 in Hex = **0C** = msb
- 4) remainder 2 in Hex = **02** = lsb
- 5) SysEx Instrument Number = 

lsb
<b>02</b>

msb
<b>0C</b>

The complete message to change the primary instrument to #02:  
**F0 18 0A dd 03 17 00 02 0C F7**

## • 14-bit Signed 2's Complement Numbers

If the data value is negative, you must first take the 2's complement of the number: In the case of a 14-bit number this is equivalent to adding 16384 to the original negative value.

To fit the 7-bit MIDI protocol, numbers must be “nibble-ized”.

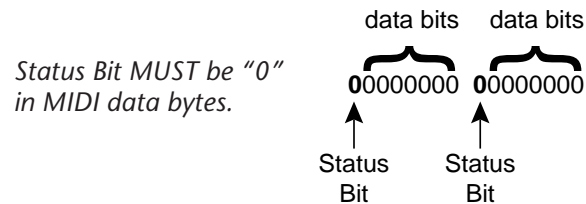

To get the 14-bit nibble-ized value (of a positive value or a 2's complemented negative value):

msb = value DIV 128 (divide and ignore the remainder)

lsb = value MOD 128 (divide and use only the remainder)

To go the other way (convert 14 bit signed 2's complement to a signed real number)

raw Value = (msb\*128) + lsb (gives you the unsigned raw value)

if raw Value  $\geq 8192$  (8192 =  $2^{13}$ )

then signed Value = raw value - 16384 (16384 =  $2^{14}$ )

**Example:** To find the “nibble-ized” Hex value of -127:

- 1)  $-127 + 16384 = \mathbf{16252}$
- 2)  $16252 \div 128 = \mathbf{126 \text{ r-}124}$
- 3) 126 in Hex = **7E** = msb
- 4) 124 in Hex = **7C** = lsb
- 5) Parameter value would be transmitted as **7C 7E**

**Example:** To find the “nibble-ized” Hex value of parameter number 257:

- 1)  $257 \div 128 = \mathbf{2 \text{ r-}1}$
- 2) 2 in Hex = **02** = msb
- 3) 1 in Hex = **01** = lsb
- 4) Parameter number would be transmitted as **01 02**

- **Note 10 - Patchcord Destinations**

The order in which patchcord destinations appear on the screen does not necessarily match the SysEx ordering. This is necessary for various reasons, one being to maintain Proteus compatibility.

### **Key/Velocity Controllers**

<b>MIDI value</b>	<b>Destination</b>
0	Off
1	Pitch
2	Pri. Pitch
3	Sec. Pitch
4	Volume
5	Pri. Volume
6	Sec. Volume
7	Attack
8	Pri. Attack
9	Sec. Attack
10	Decay
11	Pri. Decay
12	Sec. Decay
13	Release
14	Pri. Release
15	Sec. Release
16	Crossfade
17	LFO 1 Amount
18	LFO 1 Rate
19	LFO 2 Amount
20	LFO 2 Rate
21	Aux. Envelope Amount
22	Aux. Envelope Attack
23	Aux. Envelope Decay
24	Aux. Envelope Release
25	Sound Start
26	Pri. Sound Start
27	Sec. Sound Start
28	Pan
29	Pri. Pan
30	Sec. Pan
31	Tone
32	Pri. Tone
33	Sec. Tone

## *Key/Velocity Controllers (cont)*

<b>MIDI value</b>	<b>Destination</b>
34	Filter Fc
35	Pri. Filter Fc
36	Sec. Filter Fc
37	Filter Q
38	Pri. Filter Q
39	Sec. Filter Q
40	Portamento Rate
41	Pri. Portamento Rate
42	Sec. Portamento Rate

## *Realtime Controllers*

<b>MIDI value</b>	<b>Destination</b>
0	Off
1	Pitch
2	Pri. Pitch
3	Sec. Pitch
4	Volume
5	Pri. Volume
6	Sec. Volume
7	Attack
8	Pri. Attack
9	Sec. Attack
10	Decay
11	Pri. Decay
12	Sec. Decay
13	Release
14	Pri. Release
15	Sec. Release
16	Crossfade
17	LFO 1 Amount
18	LFO 1 Rate
19	LFO 2 Amount
20	LFO 2 Rate
21	Aux. Envelope Amount
22	Aux. Envelope Attack
23	Aux. Envelope Decay
24	Aux. Envelope Release

*Realtime Controllers (cont)*

<b>MIDI value</b>	<b>Destination</b>
34	Filter Fc
35	Pri. Filter Fc
36	Sec. Filter Fc
40	Portamento Rate
41	Pri. Portamento Rate
42	Sec. Portamento Rate

Please read this warranty, as it gives you specific legal rights.

## ***Length of Warranty***

This warranty covers all defects in materials and workmanship for a period of one year from the date of purchase by the original owner, provided that the Warranty Registration Card is filled out and returned to E-mu Systems within 14 days from the date of purchase. Cases may arise where E-mu's Service Department or one of E-mu's authorized service centers will ask for a copy of your sales receipt to facilitate warranty service. Please keep your purchase receipt in a safe place.

## **E-mu Systems does not cover:**

- Damages due to improper or inadequate maintenance, accident, abuse, misuse, alteration, unauthorized repairs, tampering, or failure to follow normal operating procedures as outlined in the owner's manual.
- Deterioration or damage of the cabinet.
- Damages occurring during any shipment of the product for any reason.
- An E-mu product that has in any way been modified by anyone other than E-mu Systems, Inc.

## ***Limitation of Implied Warranties***

No warranty is expressed or implied. E-mu Systems specifically disclaims the implied warranties of merchantability and fitness for a particular purpose.

## ***Exclusion of Certain Damages***

E-mu Systems' liability for a product found defective is limited to repair or replacement of the unit, at E-mu's option. In no event shall E-mu Systems be liable for damages based on inconvenience, whether incidental or consequential, loss of use of the unit, loss of time, interrupted operation or commercial loss, or any other consequential damages.

*Some states do not allow limitation of the duration of implied warranties or the exclusion or limitation of incidental or consequential damages, so the above limitations and exclusions may not apply to you.*

## ***How To Obtain Warranty Service***

All E-mu products are manufactured with the highest standards of quality. If you find that your instrument does require service, it may be done by an authorized E-mu service center. If you are unable to locate a service center in your area, please contact E-mu Systems Service Department at (408) 438-1921. They will either refer you to an authorized service center or ask that you return your instrument to the factory.

When returning an instrument to the factory, you will be issued a Return Authorization number (RA). Please label all cartons, shipping documents and correspondence with this number. E-mu suggests you carefully and securely pack your instrument for return to the factory. Mark the outside of the shipping carton clearly with your RA number. Send to E-mu Systems, Inc. 1600 Green Hills Road, Scotts Valley, California, 95066. You must pre-pay shipping charges to the service location. E-mu Systems will pay return shipping fees. You will be responsible for any damage or loss sustained during shipment in any direction.

11/92

**A**

Aftertouch 29  
 See also Pressure  
 Alternate tunings 24, 64  
 Alternate volume envelope 30, 50, 72  
 Attack 30, 50, 57, 72, 73, 75  
 Auxiliary envelope 30, 57, 75

**B**

B3 Wave  
 Charts 95-97  
 Listing 91  
 Balance 36  
 Basic operation 9  
 Basic sampling system diagram 14  
 Basic setup 5  
 Block diagram, Vintage Keys 36, 37, 39

**C**

Channel pan 12  
 Channel volume 12  
 Character chart 46  
 Chorus 52, 71  
 Coarse tuning 49, 70  
 Continuous controller 40  
 Contour  
 See Envelope generator  
 Crossfade  
 Amount 55  
 Balance 54  
 Direction 54  
 Mode 53  
 Cross-switch 29, 53-55, 62  
 Curves, velocity 38  
 Cutoff frequency 34, 56

**D**

Data entry control 11  
 DCA 33, 36, 50, 72  
 Decay 30, 50, 57, 72  
 Delay  
 Envelope 30, 57  
 Instrument 51  
 LFO 58  
 Demo sequences 13  
 Dimensions: 100  
 Display 23  
 Drawbar settings 95-97  
 Drum  
 Charts 98-100  
 Listing 90

**E**

Edit menu select 11, 45  
 Editing presets 43-66, 70  
 Effect returns 8  
 Effect devices 7, 8, 81  
 Enter 11  
 Envelope Generators 29, 30, 57  
 Equal tuning 64

**F**

Factory presets 23, 84-87  
 Fc 34  
 Filter 33-36, 55, 56, 73, 74  
 Filter Modulation 33, 60, 61, 73, 74  
 Fine tuning 49  
 Footswitch 22, 29, 62

**G**

Gamelan tuning 64  
 Glide  
 See portamento  
 Global bend 18  
 Global velocity curve 18-19

**H**

Harmonic waveforms 92  
 Headphone 5  
 Hold 30, 57  
 Home/Enter button 11

**I**

ID number 20  
 Instrument 4  
 Listing 88-94  
 Selection 36  
 Inverting 32

**J**

Javanese tuning 64  
 Just C tuning 64

**K**

Key number 38, 60, 64  
 Chart  
 Key range 47  
 Key velocity 29, 37, 38, 60, 63



## Keyboard

- Center 38, 64
- Connection 5-7
- Layered 27, 48, 65, 69
- Modulation 29, 37, 60, 64
- Pressure 29
- Split 27, 48, 65, 69
- Tuning 64

## L

- Layering 27, 65
- Legato 52
- LFO 28, 29, 31, 58, 59
- Link preset 4, 27, 65, 69
- Loops, instrument 94
- Low frequency oscillators 29, 31
- Low pass filter 33-36, 55, 56, 73, 74

## M

- Main controls 11
- Main outputs 6
- Master menu select 11, 17
- Master settings 23
- Master tune 17
- MIDI 40
  - Basic info 40, 41
  - Connections 5, 7
  - Activity LED 11
  - Channel selection 12
  - Controller 29
  - Controller amount 62
  - Controller assign 22
  - Controllers A-B-C-D 41, 62
  - Enable 21
  - Footswitch assign 22
  - Implementation chart 102
  - In 5, 6, 7
  - Mode 20-21
  - Mode change 21
  - Out 6, 22
  - Overflow 20
  - Program → Preset 22-23
  - Realtime controllers 40
  - Recording SysEx data 23, 104
  - Specifications 102-116
  - System exclusive 103-117
  - Thru 7
  - MIDI-patch 32, 40
- Mix outputs 20, 42, 65

## Modulation 28

- destination 28
- filter 33
- footswitch 22, 62
- source 28-41, 61
- Mono mode 20
- Mono output 5
- Multi mode 20
- Multi-cycle waveforms 94
- Multi-mode 13
- Multi-timbral operation 13

## O

- Omni mode 20
- Organ waveforms 91
- Organization basic 4
- Output impedance: 101
- Output level: 100
- Outputs 5, 6, 7, 20, 42, 65
- Overflow 20

## P

- Pan 36
  - Channel pan 12
  - Modulation 37, 60
  - Preset pan 49
- Patch 32
- Percussion instrument
  - Diagrams 98-100
  - Listing 90
- Performance setup 7
- Piles 93
- Pitch modulation 60, 61
- Pitch bend range 62
- Pitch wheel 29
- Poly mode 20
- Poly key pressure 29
- Portamento 52
  - Rate 52
- Power 8, 101
  - 110/220 8
- Power switch 11
- Preset 4
  - Change 2
  - Factory preset listing 84-87
  - Links 65
  - Mapping 22-23
  - Naming 46
  - Recording to a sequencer 23
  - Saving 66
  - Selection 12

Pressure, key 29, 39, 61  
Amount 62

Primary 4  
Filter type 55  
Instrument 47  
Key range 48

Program/Presets map 22-23  
Programming basics 25

## Q

Q 35, 56, 74

## R

Random 31  
Rate, LFO 58  
Realtime modulation 29, 39, 61  
Release 30, 50, 57, 72  
Resonance 35  
Reverb spaces 78, 100  
Reverse sound 51  
Ripoff 81

## S

Sample & hold 31  
Sample playback rate: 101  
Sample start point 51  
Sampled sounds 88-94  
Save preset 66  
Sawtooth 31  
Secondary 4  
Instrument 47  
Key range 48  
Send MIDI data 23  
Send/Return cables 7  
Setup 5-7  
Sequencing 79, 80  
Multi-timbral 13  
Sequencer hookup 6  
Signal flow 36-39  
Sine wave  
Instrument 92  
LFO 31  
Single cycle waveforms 93  
Solo mode 52  
Sound start 51  
Modulation 60  
Sound wave 36  
Split keyboard 27, 48, 65, 69  
Square wave 31  
Stereo outputs, 5-8, 20, 42, 65  
Studio setup 6

Sub 1 & 2 outputs 7, 8, 42  
Submix returns 7, 8, 81

Sustain  
Envelope generator 30, 50, 57, 72  
Pedal/footswitch 62  
Synth mode 52  
Synthesizer waveforms 91  
SysEx 104-117

## T

Technical specifications 101  
Temperament 24  
Tone 33, 36, 37, 60  
Transpose 18  
Tremolo 58  
Triangle wave 31  
Tuning  
Master 17  
Course & fine 49  
Tuning table 23, 24

## U

User key tuning 24  
User presets 23

## V

Variation, LFO 58  
Vallotti tuning 64  
Velocity 63  
Velocity curve  
Global velocity curve 18-19  
Velocity curves 38, 63  
Velocity modulation 29, 37, 60  
Vibrato 58  
Vintage synthesis 77  
Viewing angle 24  
Volume  
MIDI channel volume 12  
Preset volume 49  
Volume control 11

## W

Warranty 118  
Waveform, LFO 31  
Weight: 101  
Wind controller mode 52  
Wind controller tip 40

## X

Xfade 53  
Xswitch 53

